

Intel[®] 7 Series Family- Intel[®] Management Engine Firmware 8.1

1.5MB Firmware Bring Up Guide

July 2012

| Revision 8.1.0.1248 - PV Release

Intel Confidential



INFORMATION IN THIS DOCUMENT IS PROVIDED IN CONNECTION WITH INTEL PRODUCTS. NO LICENSE, EXPRESS OR IMPLIED, BY ESTOPPEL OR OTHERWISE, TO ANY INTELLECTUAL PROPERTY RIGHTS IS GRANTED BY THIS DOCUMENT. EXCEPT AS PROVIDED IN INTEL'S TERMS AND CONDITIONS OF SALE FOR SUCH PRODUCTS, INTEL ASSUMES NO LIABILITY WHATSOEVER AND INTEL DISCLAIMS ANY EXPRESS OR IMPLIED WARRANTY, RELATING TO SALE AND/OR USE OF INTEL PRODUCTS INCLUDING LIABILITY OR WARRANTIES RELATING TO FITNESS FOR A PARTICULAR PURPOSE, MERCHANTABILITY, OR INFRINGEMENT OF ANY PATENT, COPYRIGHT OR OTHER INTELLECTUAL PROPERTY RIGHT.

UNLESS OTHERWISE AGREED IN WRITING BY INTEL, THE INTEL PRODUCTS ARE NOT DESIGNED NOR INTENDED FOR ANY APPLICATION IN WHICH THE FAILURE OF THE INTEL PRODUCT COULD CREATE A SITUATION WHERE PERSONAL INJURY OR DEATH MAY OCCUR.

Intel may make changes to specifications and product descriptions at any time, without notice. Designers must not rely on the absence or characteristics of any features or instructions marked "reserved" or "undefined." Intel reserves these for future definition and shall have no responsibility whatsoever for conflicts or incompatibilities arising from future changes to them. The information here is subject to change without notice. Do not finalize a design with this information.

The products described in this document may contain design defects or errors known as errata which may cause the product to deviate from published specifications. Current characterized errata are available on request.

Contact your local Intel sales office or your distributor to obtain the latest specifications and before placing your product order.

All products, platforms, dates, and figures specified are preliminary based on current expectations, and are subject to change without notice. All dates specified are target dates, are provided for planning purposes only and are subject to change.

This document contains information on products in the design phase of development. Do not finalize a design with this information. Revised information will be published when the product is available. Verify with your local sales office that you have the latest datasheet before finalizing a design.

Intel® Active Management Technology requires activation and a system with a corporate network connection, an Intel® AMT-enabled chipset, network hardware and software. For notebooks, Intel® AMT may be unavailable or limited over a host OS-based VPN, when connecting wirelessly, on battery power, sleeping, hibernating or powered off. Results dependent upon hardware, setup & configuration. For more information, visit <http://www.intel.com/technology/platform-technology/intel-amt>.

No system can provide absolute security under all conditions. Requires an enabled chipset, BIOS, firmware and software, and a subscription with a capable Service Provider. Consult your system manufacturer and Service Provider for availability and functionality. Intel assumes no liability for lost or stolen data and/or systems or any other damages resulting thereof. For more information, visit <http://www.intel.com/go/anti-theft>.

KVM Remote Control (Keyboard, Video, Mouse) is only available with Intel® Core™ i5 vPro and Core™ i7 vPro processors with Intel® Active Management technology activated and configured and with integrated graphics active. Discrete graphics are not supported.

Systems using Client Initiated Remote Access require wired LAN connectivity and may not be available in public hot spots or "click to accept" locations.

Warning: Altering clock frequency and/or voltage may (i) reduce system stability and useful life of the system and processor; (ii) cause the processor and other system components to fail; (iii) cause reductions in system performance; (iv) cause additional heat or other damage; and (v) affect system data integrity. Intel has not tested, and does not warranty, the operation of the processor beyond its specifications.

Code names featured are used internally within Intel to identify products that are in development and not yet publicly announced for release. Customers, licensees and other third parties are not authorized by Intel to use code names in advertising, promotion or marketing of any product or services and any such use of Intel's internal code names is at the sole risk of the user.

Intel, Intel® vPro™, and the Intel logo are trademarks of Intel Corporation in the U.S. and other countries.

*Other names and brands may be claimed as the property of others.

Copyright © 2012, Intel Corporation. All rights reserved.



Table of Contents

1	Introduction	8
1.1	Related Documentation	8
1.2	Intel® ME FW Features	8
1.3	Prerequisites.....	9
1.4	Acronyms and Definitions	9
1.4.1	General.....	9
1.4.2	Intel® Management Engine	10
1.4.3	System States and Power Management	11
1.5	Reference Documents	12
1.6	Format and Notation	12
1.7	Kit Contents.....	13
1.8	External Hardware Requirements for Bring Up	16
2	Image Creation: Flash Image Tool (FITC)	17
2.1	Start FITC and Set Up The Build Environment.....	17
2.2	Configure PCH Silicon Stepping.....	20
2.3	Set Up SPI Flash Regions.....	20
2.4	Set Up Descriptor and SPI Flash Device(s)	23
2.4.1	Set Up Soft-Straps.....	29
2.5	Configure PCH Silicon SKU	36
2.6	Intel® ME FW Feature Configuration.....	37
2.6.1	Firmware Features and Capabilities	38
2.6.2	Clock Control Parameters.....	44
2.7	Build SPI Flash Binary Image	47
2.7.1	Build SPI Flash Binary Image.....	49
2.7.2	Save Your Settings	50
2.7.3	Protect Saved Configuration XML File.....	50
3	Programming SPI Flash Devices and Checking Firmware Status	53
3.1	Flash Burner/Programmer.....	53
3.2	Flash Programming Tool (FPT)	53
3.2.1	FPT Windows* Version.....	54
3.3	Checking Intel® ME Firmware Status.....	55
3.4	Common Bring Up Issues and Troubleshooting Table	57
A	Appendix — Flash Configurations	59
B	Appendix — Intel® C600 Series Express Chipsets Clock Configuration	61
B.1	Functional Blocks.....	62
B.2	Clock Configuration XML	63
B.3	Intel® ME FW Clock Control Parameters.....	63
B.3.1	CSS – Clock Source Select	63
B.3.2	SSS – SRC Source Select	64
B.3.3	FCSS – Flex Clock Source Select	65

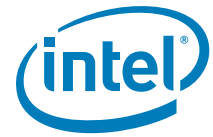

B.3.4	PLLRCs – PLL Reference Clock Select	69
B.3.5	DPLLAC – Display PLL “A” Configuration	70
B.3.6	DPLLBC – Display PLL “B” Configuration	70
B.3.7	PLEN – PLL Enable	70
B.3.8	OCKEN – Output Clock Enable	70
B.3.9	IBEN – Input Buffer Enable	72
B.3.10	DIVEN – Divider Enable	73
B.3.11	PM1 – Power Management	74
B.3.12	PM2 – Power Management	74
B.3.13	SEBP1 – Single Ended Buffer Parameters	75
B.3.14	SEBP2 – Single Ended Buffer Parameters	76
B.3.15	SSCCTL – SSC Control.....	78
B.3.16	PMSRCCLK1 – SRC Power Management	79
B.3.17	PMSRCCLK2 – SRC Power Management	81
B.3.18	PI12BiasParms – Phase Interpolators 1 & 2 Biasing Parameters	83
B.3.19	SSC2OCPARMS – SSC2 Overclock Parameters	83
B.3.20	PCH Clock output / ICC registers mapping - part A	83
B.3.21	PCH Clock output / ICC registers mapping - part B	86



Figures

2-1	Build Environment Variables	18
2-2	Build Build Settings... ..	19
2-3	PCH Silicon Stepping Combo Box	20
2-4	SKU Manager Combo Box	37
2-5	Manageability Application Warning	41
2-6	Build Build Image	50
2-7	Protecting FITC Configuration XML File	51
A-1	Configuration "A" — Desktop/Server/Workstation or Mobile	59
A-2	Configuration "B" — Mobile Only	59
A-3	Configuration "C" — Desktop/Server/Workstation Only	60
A-4	Configuration "D" — Mobile Only	60
B-1	Intel® 7 Series/C216 Chipset Family Full Clock Integration Mode Architecture.....	61

Tables

1-1	Number Format Notation	12
1-2	Data Format Notation.....	12
1-3	Kit Contents.....	13
2-1	Flash Image PDR Region	20
2-2	Flash Image GbE Region.....	21
2-3	Flash Image ME Region	22
2-4	Flash Image BIOS Region	23
2-5	Flash Image Descriptor Region	23
2-6	Flash Image Descriptor Region Descriptor Map	24
2-7	Flash Image Descriptor Region Component Section.....	25
2-8	Flash Image Descriptor Region Master Access Section CPU/BIOS	26
2-9	Flash Image Descriptor Region Master Access Section Manageability Engine (ME) 26	
2-10	Flash Image Descriptor Region Master Access Section GbE LAN	27
2-11	Flash Image Descriptor Region VSCC Table Add Table Entry.....	27
2-12	Flash Image Descriptor Region VSCC Table W25Q64BV (example)	28
2-13	Flash Image Descriptor Region OEM Section	28
2-14	Flash Image Descriptor Region PCH Straps PCH Strap 0	29
2-15	Flash Image Descriptor Region PCH Straps PCH Strap 2	30
2-16	Flash Image Descriptor Region PCH Straps PCH Strap 4	30
2-17	Flash Image Descriptor Region PCH Straps PCH Strap 7	31
2-18	Flash Image Descriptor Region PCH Straps PCH Strap 9	32
2-19	Flash Image Descriptor Region PCH Straps PCH Strap 10	33
2-20	Flash Image Descriptor Region PCH Straps PCH Strap 11	34
2-21	Flash Image Descriptor Region PCH Straps PCH Strap 15	35
2-22	Flash Image Descriptor Region PCH Straps PCH Strap 16	36
2-23	Flash Image Descriptor Region PCH Straps PCH Strap 17	36
2-24	Flash Image ME Region Configuration ME	38

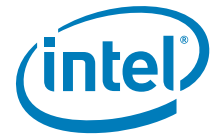

2-25	Flash Image ME Region Configuration Power Packages	40
2-26	Flash Image ME Region Configuration Features Supported	40
2-27	Flash Image ME Region Configuration Intel® Anti-Theft Technology	41
2-28	Flash Image ME Region Configuration ME Debug Event Service	42
2-29	43
2-30	Flash Image ME Region Configuration ICC Data ICC Profile 0 FCIM/BTM Specific Registers.....	44
2-31	Flash Image ME Region Configuration ICC Data ICC Profile 0 ICC Registers .	45
2-32	Flash Image ME Region Configuration ICC Data ICC Profile 0 Clock Range Definition Record 0	47
3-1	Common Bring Up Issues and Troubleshooting Table	57
B-1	SSC Blocks	62
B-2	Clock Dividers	62
B-3	Clock Source Select Parameters.....	64
B-4	SRC Source Select Parameters	65
B-5	Flex Clock Source Select Parameters	66
B-6	PLL Reference Clock Select Parameters.....	69
B-7	PLL Enable Parameters	70
B-8	Output Clock Enable Parameters	71
B-9	Input Buffer Enable Parameters	72
B-10	Divider Enable Parameters	73
B-11	Power Management Parameters.....	74
B-12	Power Management Parameters.....	75
B-13	Single Ended Buffer Parameters.....	75
B-14	Single Ended Buffer Parameters.....	77
B-15	SSC Control Parameters	78
B-16	SRC Power Management.....	80
B-17	SRC Power Management.....	82
B-18	Phase Interpolators 1 & 2 Biasing Parameters.....	83
B-19	SSC2 Overclock Parameters	83
B-20	PCH Clock output / ICC registers mapping - part A	84
B-21	PCH Clock output / ICC registers mapping - part B	87

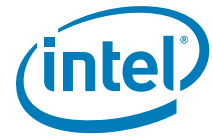

Revision History

Revision	Description	Date
8.1.0.1237	Beta Release: See change bars on the left side of the page	March 2012
8.1.0.1248	PC Release: See change bars on the left side of the page	June 2012
8.1.0.1248	PV Release: See change bars on the left side of the page	July 2012

§ §



1 Introduction

This document covers the Intel® Management Engine Firmware (Intel® ME) 8.1 - 1.5MB SKU Firmware bring up procedure. Intel® ME is tied to essential platform functionality — this dependency cannot be avoided for engineering reasons.

The bring up procedure primarily involves building a Serial Peripheral Interface (SPI) Flash image that will contain:

- **[required]** Descriptor region — Contains sizing information for all other SPI Flash image regions, SPI settings (including Vendor Specific Configuration - or VSCC - tables, SPI device parameters), and region access permissions.
- **[required]** BIOS region — Contains firmware for the processor (or host) and/or Embedded Controller (EC).
- **[required]** Intel® ME FW region — Contains firmware for the Intel® Management Engine.
- **[optional]** GbE region — Contains firmware for Intel® LAN solution.

For more details on SPI Flash layout, see the document *Intel® 7 Series/C216 Chipset Family SPI Flash Programming Guide* and [Appendix A](#). Once the SPI Flash image is built, it will be programmed to the target Intel® 7 Series/C216 Chipset Family based platform and the platform will be booted. This document also covers any tests and checks required to ensure that this boot process is successful and that Intel® ME 1.5MB FW is operating as expected.

1.1 Related Documentation

VIP: Kit# 474804 - Intel® Ethernet Network Connections (16.3 PC OEM Gen) - LAN Software Drivers -- 05-May-2011 LAN Access Division (LAD) - V16.3C00061 TIC = 239717 .Release 16.3 Production Candidate with selected bug fixes for E1K, E1C and IXE silicon products.

1.2 Intel® ME FW Features

This firmware release includes the following applications:

- Platform Clocks – Tune Intel® 7 Series/C216 Chipset Family clock silicon to the parameters of a specific board, configure clocks at run time, and power management clocks. **Benefit:** Allows extensive customizability and soft control of “Third generation” clock solution and makes clocks available before CPU powers up.
- Silicon Workaround Capability – Intel® ME FW will have limited capabilities to perform targeted workarounds for silicon issues. **Benefit:** Allows Intel® ME FW to address some issues that otherwise would require a new silicon stepping.
- Thermal Reporting – Intel® ME FW has the ability to collect platform thermal data and provide that data to embedded controllers and super I/O devices over SMLINK1 as well as in memory map I/O space.



1.3 Prerequisites

Before this document is read and utilized, it is essential that the reader first review the 1.5MB FW Release Notes (included with this Intel® ME 1.5MB FW kit).

This document is constructed so that the reader can complete the bring up steps as given for the Intel Customer Reference Board (CRB). However, in the case that bring up is being performed on a different Intel® 7 Series Family based platform, this document will highlight any changes that must be imposed onto the bring up steps accordingly.

This document makes only the following limited assumptions regarding hardware:

- The platform is Intel® 7 Series Family based
- The platform is equipped with one or more SPI Flash devices with a total capacity sufficient for storing all relevant firmware images.

1.4 Acronyms and Definitions

1.4.1 General

Acronym or Term	Definition
API	Application Programming Interface
ASCII	American Standard Code for Information Interchange
BIOS	Basic Input Output System
CPU	Central Processing Unit
DIMM	Dual In-line Memory Module
DLL	Dynamic Link Library
DMI	Direct Media Interface
EC	Embedded Controller
EEPROM	Electrically Erasable Programmable Read Only Memory
FDI	Flexible Display Interface
FW	Firmware
GbE	Gigabit Ethernet
HECI	Host Embedded Controller Interface (aka Intel® MEI)
IBV	Independent BIOS Vendor
ID	Identification
Intel® ME	Intel® Management Engine (Intel®ME)
Intel® MEI	Intel® Management Engine Interface (Intel® MEI) (renamed from HECI)
Intel® IPT	Intel® Identity Protection Technology (Intel® IPT)
IMSS	Intel® Management and Security Status Application
ISV	Independent Software Vendor
JTAG	Joint Test Action Group
KVM	Keyboard, Video, Mouse
LAN	Local Area Network
LED	Light Emitting Diode
NVM	Non-Volatile Memory

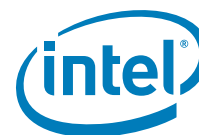

Acronym or Term	Definition
NVRAM	Non-Volatile Random Access Memory
OOB	Out-of-Band
OS	Operating System
PAVP	Protected Audio and Video Path
PCI	Peripheral Component Interconnect
PCIe*	Peripheral Component Interconnect Express
PHY	Physical Layer (Networking)
PRTC	Protected Real Time Clock
RNG	Random Number Generator
RSA	RSA is a public key encryption method
RTC	Real Time Clock
SDK	Software Development Kit
SHA	Secure Hash Algorithm
SMBus	System Management Bus
SPI Flash	Serial Peripheral Interface Flash
TCP/IP	Transmission Control Protocol / Internet Protocol
TPM	Trusted Platform Module
UI	User Interface
UNS	User Notification Service
VSCC	Vendor Specific Configuration
WMI	Windows Management Instrumentation

1.4.2 Intel® Management Engine

Acronym or Term	Definition
3PDS	3rd Party Data Storage
Agent	Software that runs on a client PC with OS running
Intel® AT	Intel® Anti-Theft Technology (Intel® AT)
End User	The person who uses the computer (either Desktop or Mobile). In corporate, the user usually does not have an administrator privileges.
Host or Host CPU	The processor that is running the operating system. This is different than the management processor running the Intel® Management Engine Firmware.
Host Service/Application	An application that is running on the host CPU
INF	An information file (.inf) used by Microsoft* operating systems that supports the Plug & Play feature. When installing a driver, this file provides the OS the necessary information about driver filenames, driver components, and supported hardware.
Intel® Management Engine Interface (Intel® MEI)	Interface between the Management Engine and the Host system
Intel® MEI driver	Intel® ME host driver that runs on the host and interfaces between ISV Agents and the Intel® ME HW.
IT User	Information Technology User. Typically very technical and uses a management console to ensure multiple PCs on a network function.



Acronym or Term	Definition
LMS	Local Management Service: A SW application which runs on the host machine and provide a secured communication between the ISV agent and the Intel® Management Engine Firmware.
Intel® ME	Intel® Management Engine: The embedded processor residing in the chipset PCH
MECI	ME-VE Communication Interface
NVM	Non-Volatile Memory: A type of memory that will retain its contents even if power is removed.
OOB Interface	Out Of Band interface: This is SOAP/XML interface over secure or non-secure TCP protocol.
OS not Functional	The Host OS is considered non-functional in Sx power state and any one of the following cases when system is in S0 power state: <ul style="list-style-type: none"> • OS is hung • After PCI reset • OS watch dog expires • OS is not present
System States	Operating System power states such as S0. See detailed definitions in System States and Power Management section.
UIM	User Identifiable Mark

1.4.3 System States and Power Management

Acronym or Term	Definition
G3	A system state of Mechanical Off where all power is disconnected from the system. G3 power state does not necessarily indicate that RTC power is removed.
M0	Intel® Management Engine power state where all HW power planes are activated. The host power state is S0.
M3	Intel® Management Engine power state where all HW power planes are activated however the host power state is different than S0 (Some host power planes are not activated). Host PCIe* interface are unavailable to the host software. Main memory is not available for Intel® Management Engine use.
M-Off	No power is applied to the management processor subsystem. Intel® Management Engine is not operating.
OS Hibernate	System state where the OS state is saved on the hard drive.
S0	A system state where power is applied to all HW devices and the system is running normally.
S1, S2, S3	A system state where the host CPU is halted but power remains available to the memory system (memory is in self-refresh mode).
S4	A system state where the host CPU and memory are not active.
S5	A system state where all power to the host system is off, however the power cord (and/or battery in mobile designs) is still connected.
Shut Down	Equivalent to the S5 state.
Snooze Mode	Intel® Management Engine activities are mostly suspended to save power. The Intel® Management Engine monitors HW activities and can restore its activities depending on the HW event.
Standby	System state where the OS state is saved in memory and resumed from the memory when mouse/keyboard is clicked.
Sx	All S states which are different than S0.

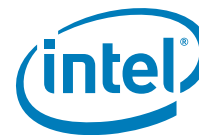

1.5 Reference Documents

Document	Doc Number / Location*
<i>Maho Bay and Carlow-WS – Platform Design Guide</i>	473718 / IBL
<i>Chief River Mobile CRB– Platform Design Guide</i>	29635 / IBL
<i>Intel® Management Engine (Intel® ME) and Embedded Controller Interaction for Chief River Platform</i>	471984 / IBL
<i>RS – Intel® Management Engine BIOS Writers Guide</i>	31007 / *
<i>[Maho Bay / Chief River / Carlow] Platforms - Intel® Management Engine (Intel® ME) 8.0 - 1.5 MB SKU Firmware for Intel® 7 Series Family - Compliancy and Testing Guide -Rev. 0.8</i>	464265 / IBL
<i>Intel® 82576 and 82579 Gigabit Ethernet Controllers – Intel Software Support for Cisco's MACsec Protocol Supplicant – 10-Dec-2010</i>	461067 / IBL

Note: * Unless specified otherwise, a document can be ordered by providing its reference number to your Intel Field Applications Engineer.

1.6 Format and Notation

The formats and notations used within this document model are those typically used by BIOS vendors. This section describes the formatting and the notations that will be followed in this document.

Table 1-1. Number Format Notation

Number Format	Notation	Example
Decimal (default)	d	14d. Note that any number without an explicit suffix can be assumed to be decimal.
Binary	b	1110b
Hex	h	0Eh
Hex	0x	0x0E

Table 1-2. Data Format Notation

Data Type	Notation	Size
Bit	b	Smallest unit, 0 or 1
Byte	B	8 bits
Word	W	16 bits or 2 bytes
Double-word	DW	32 bits or 4 bytes
Quad-word	QW	8 bytes or 4 words
Kilobyte	KB	1024 bytes
Megabit	Mb	1,048,576 bits or 128 KB
Megabyte	MB	1,048,576 bytes or 1024 KB
Gigabit	Gb	1,073,741,824 bits
Gigabyte	GB	1024 MB



1.7 Kit Contents

The Intel® ME 1.5MB FW kit can be downloaded from VIP (<https://platformsw.intel.com/>). The contents of this kit are detailed below (Note that only key files are listed).

Table 1-3. Kit Contents (Sheet 1 of 4)

File or [Directory]	Content Description
[root]	Root directory
1.5MB FW Bring Up Guide.pdf	This document
1.5MB FW Getting Started Guide.pdf	1.5MB FW Getting started guide.
SPI programming guide.pdf	How to program SPI device parameters, VSCC tables, descriptor region details. Also contains a complete SPI Flash softstrap reference.
[Image Components]	
[BIOS]	
IVB091.rom	BIOS image only for Intel® CRB. This BIOS image works for both desktop and mobile CRBs. For other Intel® 7 Series Family based platforms, a custom BIOS image will be required.
[GbE]	
82579_NVM_4_DESKTOP.bin	Intel® LAN PHY firmware image, supports PHY A2 and B0 only . This image is recommended for testing power flows with connectivity. This image is for desktop platforms only.
82579_NVM_3_MOBILE.bin	Intel® LAN PHY firmware image, supports PHY A2 and B0 only . This image is recommended for testing power flows with connectivity. This image is for mobile platforms only.
[ME]	
ME8_1.5M_PreProduction.BIN	Intel® ME firmware image (Non Production FW) - supports unfused Intel® 7 Series Family PCH steppings: <ul style="list-style-type: none"> Unfused PPT ES0 (B0 Super SKU) Note: For PAVP Testing , you must match Production FW with Production Part and Non Production FW with Non Production Parts.
ME8_1.5M_Production.BIN	Intel® ME firmware image (Production FW) - supports fused and unfused Intel® 7 Series Family PCH steppings: <ul style="list-style-type: none"> Unfused PPT ES0 (B0 Super SKU) Fused PPT Pre-QS and QS Note: For PAVP Testing , you must match Production FW with Production Part and Non Production FW with Non Production Parts.
[Installers]	
Intel® ME SW Installation Guide.pdf	Intel®ME SW Installation Guide
[ME_SW]	
Setup.exe	Install executable (non-InstallShield) of Intel® ME Drivers for Windows* OS. See readme.txt for more information.
[ME_SW_IS]	

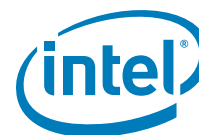

Table 1-3. Kit Contents (Sheet 2 of 4)

File or [Directory]	Content Description
ME_SW_IS.zip	Zip containing InstallShield* files of Intel® ME Drivers for Windows* OS. See readme.txt in previous directory for more information.
[Tools]	
[ICC_Tools]	
Intel(R) ME Firmware Integrated Clock Control (ICC) Tools User Guide.pdf	ICC Tools User Guide
[CCT]	
DOS	
cct.exe	Clock Control Tool (CCT)
EFI	
cct.efi	CCT for EFI
Windows	
cct.ini	Configuration file for CCT
cctWin.exe	CCT for Windows*
[System Tools]	
Open Watcom Public License.pdf	Sybase Open Watcom Public License version 1.0 document.
System Tools User Guide.pdf	System Tools User Guide
Tools_Version.txt	Tools version information
[Flash Image Tool]	
fitc.exe	Flash Image Tool (FITC & FITC Wizard)
fitc.ini	Configuration file for FITC & FITC Wizard
fitctmpl.xml	FITC Tool XML file
newfiletmpl.xml	FITC Configuration XML file
fitcwizardhelp.chm	Wizard Help text file
vsccommn.bin	Binary containing the supported SPI parts
VSCCommn_bin Content.pdf	Documentation listing the SPI parts supported by vsccommn.bin
[Flash Programming Tool]	
[DOS]	
fparts.txt	List of supported SPI Flash devices with specific Flash parameters
fpt.exe	Flash Programming Tool (FPT) for DOS
[EFI]	
fparts.txt	List of supported SPI Flash devices with specific Flash parameters
fpt.efi	Flash Programming Tool (FPT) for EFI
[Windows]	
fparts.txt	List of supported SPI Flash devices with specific Flash parameters
fptw.exe	Flash Programming Tool (FPT) for Windows*
[Windows64]	



Table 1-3. Kit Contents (Sheet 3 of 4)

File or [Directory]	Content Description
fparts.txt	List of supported SPI Flash devices with specific Flash parameters
fptw64.exe	Flash Programming Tool (FPT) for Windows* (64-bit) OS
[FWUpdate]	
[EFI]	
FWUpdLcl.efi	FW Update Tool (EFI version)
[Local-DOS]	
FWUpdLcl.exe	FW Update Tool (DOS version)
[Local-Win]	
FWUpdLcl.exe	FW Update Tool (Windows* version 32bit)
[Local-Win64]	
FWUpdLcl64.exe	FW Update Tool (Windows* version 64bit)
[MEInfo]	
[DOS]	
MEInfo.exe	Intel®ME Information Tool (DOS version)
[EFI]	
MEInfo.efi	Intel®ME Information Tool (EFI version)
[Windows]	
MEInfoWin.exe	Intel®ME Information Tool (Windows* version 32bit)
[Windows64]	
MEInfoWin64.exe	Intel®ME Information Tool (Windows* version 64bit)
[MEManuf]	
[DOS]	
MEManuf.cfg	Intel®ME Manufacturing Tool config file
MEManuf.exe	Intel®ME Manufacturing Tool (DOS version)
vsccommn.bin	Binary containing the supported SPI parts
VSCCommn_bin Content.pdf	Documentation listing the SPI parts supported by vsccommn.bin
[EFI]	
MEManuf.cfg	Intel®ME Manufacturing Tool config file
MEManuf.efi	Intel®ME Manufacturing Tool (EFI version)
vsccommn.bin	Binary containing the supported SPI parts
[Windows]	
MEManuf.cfg	Intel®ME Manufacturing Tool config file
MEManufWin.exe	Intel®ME Manufacturing Tool (Windows* version 32bit)
vsccommn.bin	Binary containing the supported SPI parts
VSCCommn_bin Content.pdf	Documentation listing the SPI parts supported by vsccommn.bin
[Windows64]	

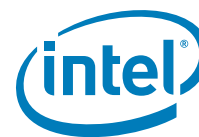

**Table 1-3. Kit Contents (Sheet 4 of 4)**

File or [Directory]	Content Description
MEManuf.cfg	Intel®ME Manufacturing Tool config file
MEManufWin64.exe	Intel®ME Manufacturing Tool (Windows* version 64bit)
vsccommn.bin	Binary containing the supported SPI parts



1.8 External Hardware Requirements for Bring Up

Acquire the following hardware tools before moving on to the next step.

Windows* OS System	Flash Burner	DOS Bootable USB Key
		
<p>Equipment:</p> <ul style="list-style-type: none"> Laptop or desktop that supports win32 applications <p>Purpose:</p> <ul style="list-style-type: none"> Will run firmware image assembly and build process software. 	<p>Equipment:</p> <ul style="list-style-type: none"> (Optional) For platforms that don't boot, a Flash Chip Programmer will be required For platforms that can boot to DOS or Windows*, a Flash Programming Tool (FPT) is provided in this kit <p>Purpose:</p> <ul style="list-style-type: none"> Will burn firmware images onto the target system Flash device(s). 	<p>Equipment:</p> <ul style="list-style-type: none"> A DOS Bootable USB Key (Size > 512 MB) <p>Purpose:</p> <ul style="list-style-type: none"> Acting as a bootable device and will be used to run Flash Programming Tool (fpt.exe) directly on the system that is undergoing Bring Up process. Or will be used to transfer a firmware image onto a Flash burner.

§ §



2 Image Creation: Flash Image Tool (FITC)

Flash Image Tool (FITC) will be used to generate a full SPI Flash binary image with Descriptor, GbE, BIOS, and Intel® ME Regions. Use the steps shown in following sections.

Note: The FITC Tool may be updated throughout the release cycles. As a general rule, please ensure you use the tools, images and other content from the same kit and refrain from using different version tools.

After this SPI Flash image is created, it will need to be burned onto the target platform's SPI Flash device(s). [Section 3, "Programming SPI Flash Devices and Checking Firmware Status"](#) later in this document provides steps to do this.

2.1 Start FITC and Set Up The Build Environment

1. Invoke Flash Image Tool. Using Explorer*, navigate to **[root]\Tools\System Tools\Flash Image Tool**. Ensure that FITC's directory contents are intact (see [Section 1.7](#)). Double-click **fitc.exe**.
2. In the main menu select **Build | Environment Variables...**. Edit your configuration as shown below. Note that in the example, **[root]\Tools\System Tools\Flash Image Tool** is **."**.
 - Keep the Working Directory \$WorkingDir as **."**
 - Source Directory \$SourceDir is where FITC will look to find binary images during the image creation process, change \$SourceDir to **".\..\..\Image Components"**
 - Destination Directory \$DestDir is where FITC will save the SPI Flash binary image, keep \$DestDir as **."**

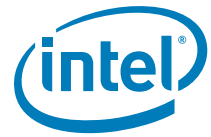
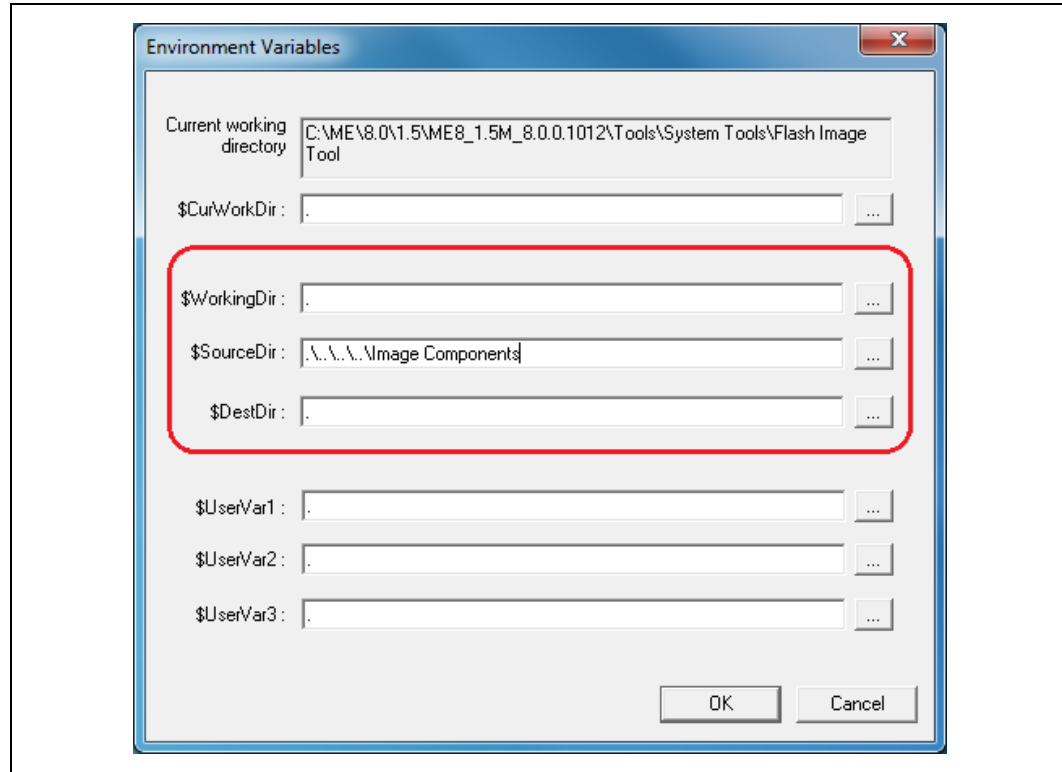
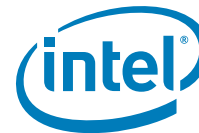

Figure 2-1. Build | Environment Variables



3. Click **OK** to apply your changes.



4. In the main menu select **Build | Build Settings....** Leave the defaults for **Output path**, **Generate intermediate build files**, and **Build compact image** as shown. Change the **Flash Block/Sector Erase Size** as appropriate for your SPI flash part(s). Click **OK** to apply your changes.

Figure 2-2. Build | Build Settings...

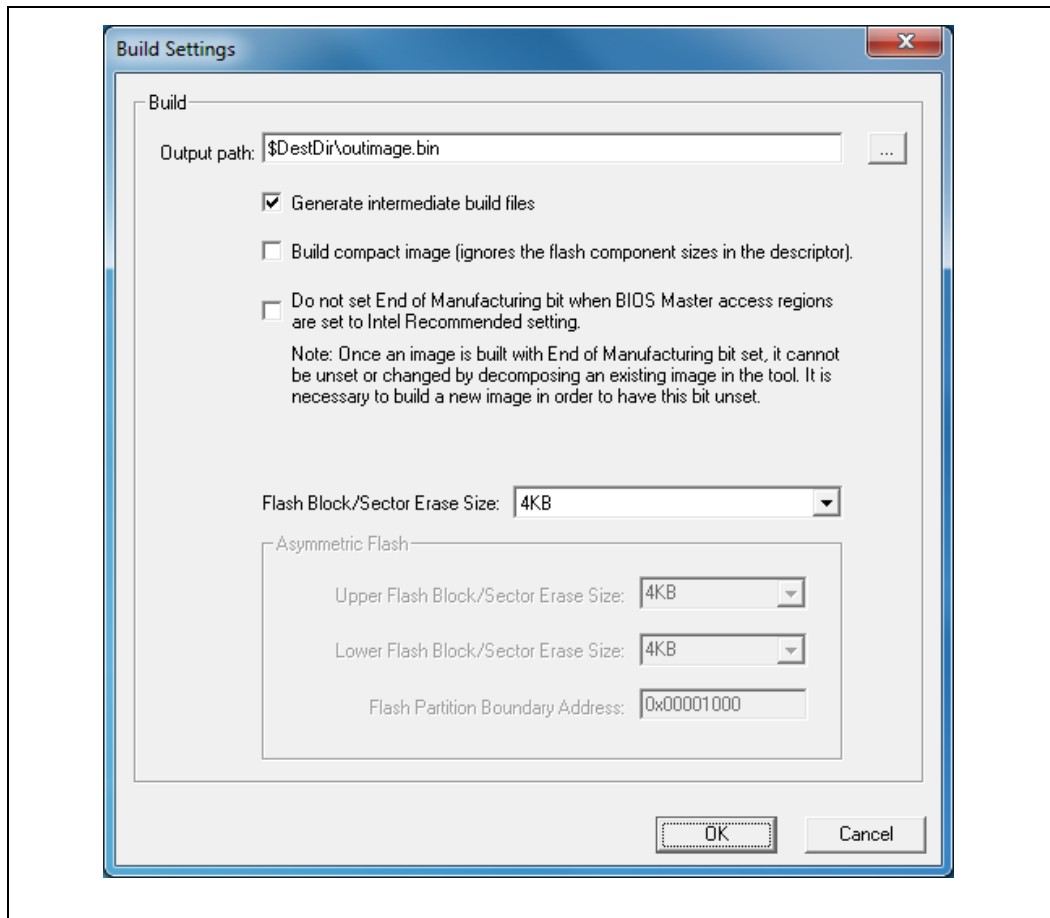

5. In the main menu select **File | Open....** In the Open dialog that appears navigate to **[root]\Tools\System Tools\Flash Image Tool**. Click on **newfiletmpl.xml** and click **OK**.



2.2 Configure PCH Silicon Stepping

Leave the **PCH Silicon Stepping Combo Box** at its default value of **Intel® 7 Series Chipset**.

Figure 2-3. PCH Silicon Stepping Combo Box

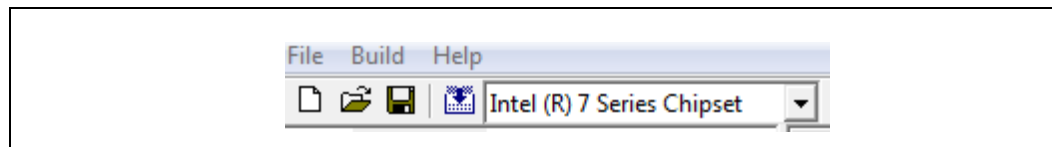

2.3 Set Up SPI Flash Regions

Table 2-1. Flash Image | PDR Region

Location	Parameter	CRB Set To	Settings for Any Platform
Follow navigation tree below: <ul style="list-style-type: none"> Select the Flash Image Select Flash Image PDR Region Set the parameters in the PDR Region section as shown 	PDR Region Length	PDR Region is enabled	Displays Region size information when Binary input file is specified.
	Binary Input File	PDR Region is enabled	Load a Platform Data Region binary if required and available.
...or if NOT using Platform Data Region (PDR)			
A red "X" will indicate whether this Region is disabled. If this Region is not disabled, disable it by right-clicking on Flash Image PDR Region and selecting Disable Region .			



Table 2-2. Flash Image | GbE Region

Location	Parameter	CRB Set To	Settings for Any Platform
Follow navigation tree below: <ul style="list-style-type: none"> Select the Flash Image Select Flash Image GbE Region Set the parameters in the GbE Region section as shown 	Yellow means custom settings may be required.		
	GbE LAN region length	0x00000000	
	Binary input file	Navigate to your Source Directory (as specified in Section 2.1) and switch to the GbE subdirectory. Choose the appropriate Intel®GbE LAN Firmware binary image. If not using Intel®LAN then leave this parameter blank.	
	Intel® Integrated LAN Enable	true	This field only is editable after an Intel® integrated LAN image is loaded. If not planning to validate Intel® LAN on target platform, or for debug reasons, set to false .
	Major Version	0	Displays major revision value for Intel® LAN GbE FW version when Binary input file is specified.
	Minor Version	0	Displays minor revision value for Intel® LAN GbE FW version when Binary input file is specified.
	Image ID	0	Displays image ID value for Intel® LAN GbE FW version when Binary input file is specified.
...or if not using Intel®wired LAN device			
A red "X" will indicate whether this Region is disabled. If this Region is not disabled, disable it by right-clicking on Flash Image GbE Region and selecting Disable Region .			

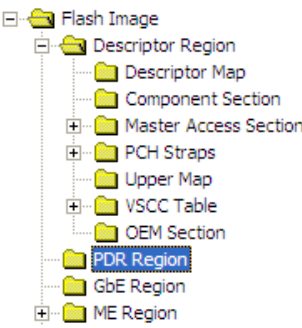
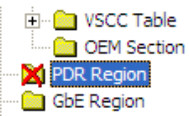

Table 2-3. Flash Image | ME Region

Location	Parameter	CRB Set To	Settings for Any Platform
<p>Follow navigation tree below:</p> <ul style="list-style-type: none"> Select the Flash Image tab Select Flash Image ME Region Set the parameters in the ME Region section as shown Note: Loading an ME FW binary image that contains ME ROM Bypass unlocks the ME Boot from Flash parameter in Flash Image Descriptor Region PCH Straps PCH Strap 10 	<p>Yellow means custom settings may be required, otherwise use CRB setting.</p>		
	Binary input file	<p>Navigate to your Source Directory (as specified in Section 2.1) and switch to the Firmware subdirectory. Choose the ME FW binary image.</p> <p>Note: You may choose to build the ME Region only. To do so, Flash Image Descriptor Region Descriptor Map parameter Number of Flash components must be set to 0.</p> <p>Note: Loading an ME FW binary image that contains ME ROM Bypass unlocks the ME Boot from Flash parameter in Flash Image Descriptor Region PCH Straps PCH Strap 10.</p>	
	PCH MTP Permit File		Treat as reserved.
	CPU MTP Permit File		Treat as reserved.
	* Partition Rom Bypass Enabled		Not a parameter. This information panel appears when an ME FW image enables ME boot directly from Flash.
	Major Version	0	Displays major revision value for ME FW version when Binary input file is specified.
	Minor Version	0	Displays minor revision value for ME FW version when Binary input file is specified.
	Hotfix Version	0	Displays hotfix value for ME FW version when Binary input file is specified.
Build Version	0	Displays build value for ME FW version when Binary input file is specified.	
<p>Note: Starting with Intel® ME 8.1, the FW image provided in the kits includes additional code partitions which are used by both full and partial FW update mechanisms as a result of these changes the image is larger than FW images from previous generations. In addition to this change the FW image in the kits will be used for generating full image binaries using FITc and full or partial FW updates using FWUplcl.</p> <p>Customers will not be able to write the image provided in the kits directly to flash. The image must be loaded into FITc tool then built in order to create a working ME region.</p>			

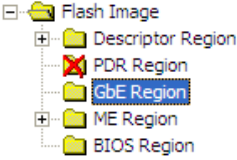
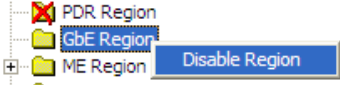

Table 2-4. Flash Image | BIOS Region

Location	Parameter	CRB Set To	Settings for Any Platform
Follow navigation tree below: <ul style="list-style-type: none"> Select the Flash Image tab Select Flash Image BIOS Region Set the parameters in the BIOS Region section as shown 	Yellow means custom settings may be required, otherwise use CRB setting.		
	BIOS region length	0x00000000	This field allows user to allocate a specific size in the SPI Flash for the BIOS image. If set to 0, FITC will automatically set the size based on the BIOS image.
	Binary input file	For the Intel® CRB navigate to your Source Directory (as specified in Section 2.1) and switch to the BIOS subdirectory. Choose the BIOS binary image.	For all other platforms point this parameter to the appropriate BIOS image. If BIOS is stored in a separate SPI Flash device or in FWH (see Configurations "B", "C", and "D" in Appendix A) then leave this parameter blank.

2.4 Set Up Descriptor and SPI Flash Device(s)

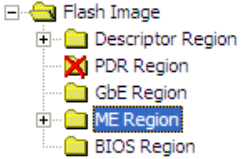
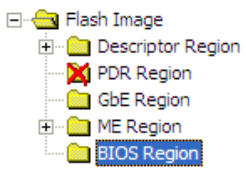
Table 2-5. Flash Image | Descriptor Region

Location	Parameter	CRB Set To	Settings for Any Platform
Follow navigation tree below: <ul style="list-style-type: none"> Select the Flash Image tab. Select Flash Image Descriptor Region Set the parameters in the Descriptor Region section as shown 	Yellow means custom settings may be required, otherwise use CRB setting.		
	Descriptor region length	0x00000000	Leave this at zero. Allows FITC to auto-size the descriptor region length.



Table 2-6. Flash Image | Descriptor Region | Descriptor Map

Location	Parameter	CRB Set To	Settings for Any Platform
Follow navigation tree below: <ul style="list-style-type: none"> • Select the Flash Image tab • Select Flash Image Descriptor Region Descriptor Map • Set the parameters in the Descriptor Map section as shown 	Yellow means custom settings may be required, otherwise use CRB setting.		
	Region base address	0x04	Read Only, See SPI programming Guide for details.
	Number of Flash components	2	Number of SPI Flash devices on the platform 1 or 2 = Total SPI Flash devices 0 = Build ME region only
	Component base address	0x03	Read Only, See SPI programming Guide for details.
	Number of PCH straps	18	Read Only, See SPI programming Guide for details.
	PCH straps base address	0x10	Read Only, See SPI programming Guide for details.
	Number of Masters	2	Read Only, See SPI programming Guide for details.
	Master base address	0x06	Read Only, See SPI programming Guide for details.
	Number of PROC straps	1	Read Only, See SPI programming Guide for details.
	PROC straps base address	0x20	Read Only, See SPI programming Guide for details.

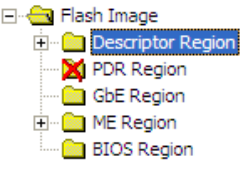
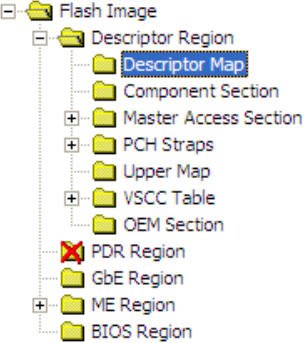
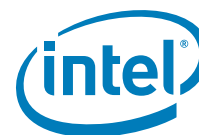

Table 2-7. Flash Image | Descriptor Region | Component Section

Location	Parameter	CRB Set To	Settings for Any Platform
Follow navigation tree below: <ul style="list-style-type: none"> Select the Flash Image tab. Select Flash Image Descriptor Region Component Section Set the parameters in the Component Section section as shown 	Yellow means custom settings may be required, otherwise use CRB setting.		
	Read ID and Read Status clock frequency	33MHz	Lowest common frequency of all SPI Flash parts on the platform.
	Write and erase clock frequency	33MHz	Lowest common frequency of all SPI Flash parts on the platform.
	Fast read clock frequency	33MHz	In order for PCH HW to override its own internal default value (20 MHz), Fast read support must be set To true .
	Fast read support	true	true = Enables opcode 0Bh opcode on a read. This allows for faster read frequencies on serial flash by having a single dummy byte before valid data is output from the flash.
	Read clock frequency	20MHz	
	Flash component 2 density	8MB	Size of second SPI Flash part on the platform. Note: This value will be grayed out if the number of SPI Flash components is set to 1 in the Descriptor Map options.
	Flash component 1 density	8MB	Size of first SPI Flash part on the platform.
	Dual Output Fast Read Support	false	This field enables the opcode 3Bh to use Single Input Dual Output Fast Read. This speeds up the fast read throughput of the serial flash part. Note: This should only be set to 'true' if all Serial Flash parts support the 3Bh command. See Intel® 7 Series Chipset SPI programming Guide for more details.
	Invalid instruction 3	0	Opcode entered here will not be allowed by the PCH's SPI controller for HW sequencing. See Intel® 7 Series Chipset SPI programming Guide for more details. 0 = no instruction is specified
	Invalid instruction 2	0	Opcode entered here will not be allowed by the PCH's SPI controller for HW sequencing. See Intel® 7 Series Chipset SPI programming Guide for more details. 0 = no instruction is specified
	Invalid instruction 1	0	Opcode entered here will not be allowed by the PCH's SPI controller. See Intel® 7 Series Chipset SPI programming Guide for more details. 0 = no instruction is specified
	Invalid instruction 0	0	Opcode entered here will not be allowed by the PCH's See Intel® 7 Series Chipset SPI programming Guide for more details. 0 = no instruction is specified
	Flash Partition Boundary	0x00000000	FPBA. Defines the boundary line between two Flash parts if they have different VSCC values. Configured in main menu option Build Build Settings (see Section 2.1).



Table 2-8. Flash Image | Descriptor Region | Master Access Section | CPU/BIOS

Location	Parameter	CRB Set To	Settings for Any Platform
Follow navigation tree below: <ul style="list-style-type: none"> Select the Flash Image tab Select Flash Image Descriptor Region Master Access Section CPU/BIOS Set the parameters in the CPU/BIOS section as shown 	Yellow means custom settings may be required.		
	PCI Bus ID	0	
	PCI Device ID	0	
	PCI Function ID	0	
	Read Access	0xFF	Controls read access by BIOS to: <ul style="list-style-type: none"> Bit 0: Descriptor (region 0) Bit 1: BIOS region (region 1) Bit 2: ME FW region (region 2) Bit 3: GbE FW region (region 3) Bit 4: PDR Region (region 4) Bits 5-7: Regions 5 through 7 0x0B = Production platform 0xFF (default) = Non-production/debug platform
	Write Access	0xFF	Controls write access by BIOS. Structure is identical to Read access parameter. 0x0A = Production platform 0xFF (default) = Non-production/debug platform

Table 2-9. Flash Image | Descriptor Region | Master Access Section | Manageability Engine (ME)

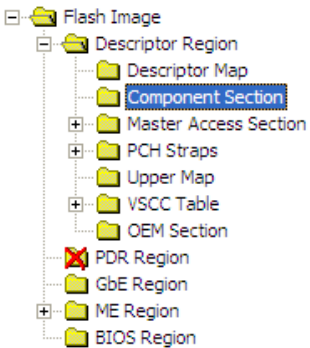
Location	Parameter	CRB Set To	Settings for target platform
Follow navigation tree below: <ul style="list-style-type: none"> Select the Flash Image tab Select Flash Image Descriptor Region Master Access Section Manageability Engine (ME) Set the parameters in the Manageability Engine (ME) section as shown 	Yellow means custom settings may be required.		
	PCI Bus ID	0	
	PCI Device ID	0	
	PCI Function ID	0	
	Read access	0xFF	Controls read access by ME to: <ul style="list-style-type: none"> Bit 0: Descriptor (region 0) Bit 1: BIOS region (region 1) Bit 2: ME FW region (region 2) Bit 3: GbE FW region (region 3) Bit 4: PDR Region (region 4) Bits 5-7: Regions 5 through 7 0x0D = Production platform 0xFF (default) = Non-production/debug platform
	Write access	0xFF	Controls write access by ME FW. Structure is identical to Read access parameter. 0x0C = Production platform 0xFF (default) = Non-production/debug platform

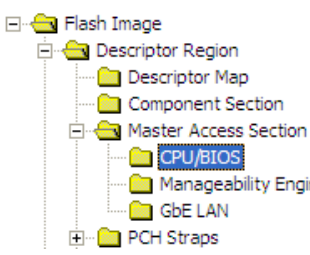
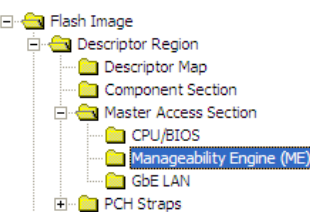
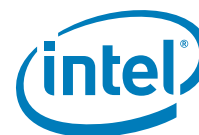

Table 2-10. Flash Image | Descriptor Region | Master Access Section | GbE LAN

Location	Parameter	CRB Set To	Settings for Any Platform
Follow navigation tree below: <ul style="list-style-type: none"> Select the Flash Image tab Select Flash Image Descriptor Region Master Access Section GbE LAN Set the parameters in the GbE LAN section as shown 	Yellow means custom settings may be required.		
	PCI Bus ID	1	1
	PCI Device ID	3	3
	PCI Function ID	0	0
	Read access	0xFF	Controls read access by GbE FW to: <ul style="list-style-type: none"> Bit 0: Descriptor (region 0) Bit 1: BIOS region (region 1) Bit 2: ME FW region (region 2) Bit 3: GbE FW region (region 3) Bit 4: PDR Region (region 4) Bits 5-7: Regions 5 through 7 0x08 = Production platform 0xFF (default) = Non-production/debug platform
Write access	0xFF	Controls write access by GbE FW. Structure is identical to Read access parameter. 0x08 = Production platform 0xFF (default) = Non-production/debug platform	

Table 2-11. Flash Image | Descriptor Region | VSCC Table | Add Table Entry

Location	Parameter	CRB Set To	Settings for Any Platform
Follow navigation tree below: <ul style="list-style-type: none"> Select the Flash Image tab Select Flash Image Descriptor Region VSCC Table Right click on VSCC Table to add entry name 	ADD Table Entry Value	Intel® CRB use W25Q64BV or AT26DF321	Set this to the name of the SPI Flash device on the target platform. <i>Note:</i> The AT26DF321 and W25Q64BV entries are created as part of the default FITC template.

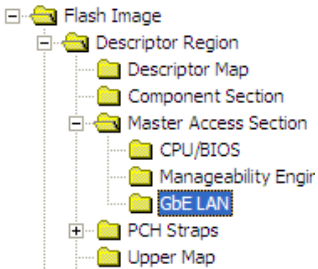

Table 2-12. Flash Image | Descriptor Region | VSCC Table | W25Q64BV (example)

Location	Parameter	CRB Set To	Settings for Any Platform
<p>Follow navigation tree below:</p> <ul style="list-style-type: none"> Select Flash Image Descriptor Region VSCC Table Set the parameters for the Atmel 4-MB SPI part in the W25Q64BV section as shown  <ul style="list-style-type: none"> Right click VSCC Table to add a Flash entry. 	<p>Yellow means custom settings may be required.</p>		
	VendorID	Intel® CRBs use 0xEF	For information on values that need to be entered in this section, refer to the Intel® 7 Series Chipset SPI programming Guide and the SPI Flash device datasheet. Vendor ID, Device ID 0 and Device ID 1 are all derived from the output of the JEDEC ID command which can be found in the vendor datasheet for the specific SPI Flash part.
	Device ID 0	Intel® CRBs use 0x40	Use values obtained by using Vendor Serial Flash datasheet and Intel® 7 Series Chipset SPI programming Guide. Default is 0x00 .
Device ID 1	Intel® CRBs use 0x17	Use values obtained by using Vendor Serial Flash datasheet and Intel® 7 Series Chipset SPI programming Guide. Default is 0x00 .	

Table 2-13. Flash Image | Descriptor Region | OEM Section

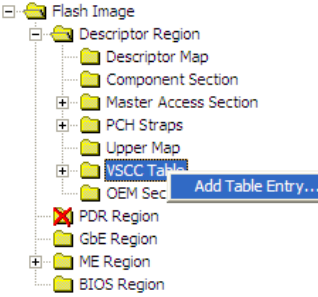
Location	Parameter	CRB Set To	Settings for Any Platform
<p>Follow navigation tree below:</p> <ul style="list-style-type: none"> Select Flash Image Descriptor Region OEM Section Set the parameters in the OEM Section section as shown 	<p>Yellow means custom settings may be required.</p>		
	Binary input file	(leave blank) Note: On Mobile CRBs modifying this value may cause Multi-BIOS not to behave properly	This is an optional field. Input depends on Customer Design and features support.

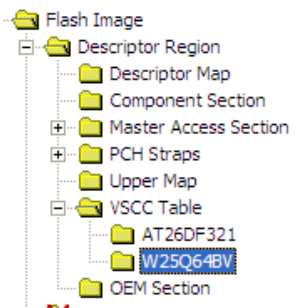
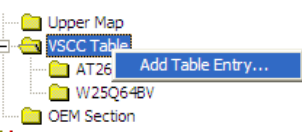
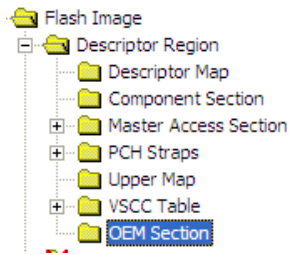
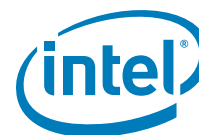

2.4.1 Set Up Soft-Straps

Table 2-14. Flash Image | Descriptor Region | PCH Straps | PCH Strap 0

Location	Parameter	CRB Set To	Settings for Any Platform
<p>Follow navigation tree below:</p> <ul style="list-style-type: none"> Select the Flash Image tab Select Flash Image Descriptor Region PCH Straps PCH Strap 0 Set the parameters in the PCH Strap 0 section as shown 	Yellow means custom settings may be required.		
	BIOS Boot Block Size	64KB	<p>BIOS Boot Block (BBB) is bare minimum BIOS code required to boot a platform. This soft-strap allows for proper address bit to be inverted as required by BBB Size.</p> <p>64KB (default) = Invert A16 if Top Swap is set</p> <p>128KB = Invert A17 if Top Swap is set</p> <p>256KB = Invert A18 if Top Swap is set</p> <p>If BIOS is stored in a separate SPI Flash device or in FWH (see Configurations "B", "C", and "D" in Appendix A) then leave this parameter at 64KB.</p> <p>Note: This must be determined by the target platform BIOS developer.</p>
	DMI RequesterID Check Disable	false	<p>Indicates if RequesterID checking during DMI accesses is disabled. This parameter should only for server platforms that contain multiple Processors.</p> <p>false (default) = Single Processor Platform</p> <p>true = Multiple Processor Platform</p> <p>Note: A quad/dual core processor counts as a single processor for this parameter.</p>
	MACsec Disable	false	<p>This setting should be set to 'false' to enable MACsec. The "MACsec ready" bit in the ME descriptor region should be enabled for support.</p> <ul style="list-style-type: none"> This bit must be set in the manufacturing plant and cannot be changed after shipment. <p>Note: If MACsec is enabled in IT infrastructure will not function properly. See 'CDI #461067' for further details.</p> <p>Note: This field is read only if Intel® integrated LAN is disabled. See Table 2-2</p>
	LANPHYPC_GP12_SEL	1	<p>1 (default) = Only required if target platform has Intel® wired LAN and PCH GP12 is used as LAN_PHYPC for Intel® LAN.</p> <p>0 = PCH GP12 is used as General Purpose Input/Output (GPIO) pin. Must be 0 if Third-party LAN and no Intel® wired LAN is present.</p> <p>Note: Please consult with the target hardware designer to determine this setting.</p>
	Intel® ME SMBus Enable	true	true = Set for all platforms
	Intel® ME SMBus Frequency	100kHz	Treat as reserved.
	SMLink0 Enable	true	true (default) = Intel® LAN is present false = Third-party LAN is present
	SMLink0 Frequency	Fast Mode	Treat as reserved.
	SMLink1 Enable	Mobile and Desktop CRB uses true	true (default) = SMLink1 is being used by EC/SIO/BMC for Thermal Reporting. false = Set for all other platforms
SMLink1 Frequency	100kHz	Treat as reserved.	
Chipset Config	true	Treat as reserved.	



Table 2-15. Flash Image | Descriptor Region | PCH Straps | PCH Strap 2

Location	Parameter	CRB Set To	Settings for Any Platform
Follow navigation tree below: <ul style="list-style-type: none"> Select the Flash Image tab Select Flash Image Descriptor Region PCH Straps PCH Strap 2 Set the parameters in the PCH Strap 2 section as shown 	Yellow means custom settings may be required.		
	SMBus I2C Address Enable (SMBI2CEN)	false	Treat as reserved.
	SMBus I2C Address (SMBI2CA)	0x00	Treat as reserved.
	Intel® ME SMBus MCTP Address Enable	false	true = Using Intel® Anti-Theft Technology with a 3G NIC false = Not using Intel® Anti-Theft Technology with a 3G NIC
	Intel® ME SMBus MCTP Address	0x2B	This field must be set to an address value if using Intel® Anti-Theft Technology with a 3G NIC 0x00 = Not using Intel® Anti-Theft Technology with a 3G NIC Note: Please consult the target hardware designer to determine this setting.
	Intel® ME SMBus ASD Address Enable (MESMASDEN)	false	Treat as reserved.
	Intel® ME SMBus ASD Address (MESMASDA)	0x00	Treat as reserved.

Table 2-16. Flash Image | Descriptor Region | PCH Straps | PCH Strap 4

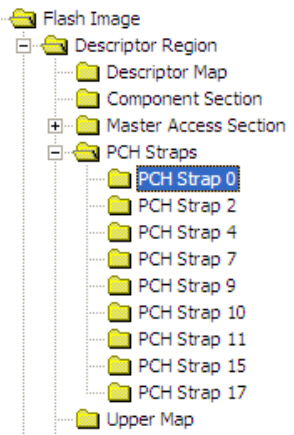
Location	Parameter	CRB Set To	Settings for Any Platform
Follow navigation tree below: <ul style="list-style-type: none"> Select the Flash Image tab Select Flash Image Descriptor Region PCH Straps PCH Strap 4 Set the parameters in the PCH Strap 4 	Yellow means custom settings may be required.		
	GbE PHY SMBus Address	0x64	Intel® wired LAN PHY SMBus address. No change required for this soft-strap value.
	GbE MAC SMBus Address	0x70	Intel® wired LAN MAC SMBus address. No change required for this soft-strap value.
	GbE MAC SMBus Address Enable	true	true (default) = Intel® integrated LAN is enabled false = Third-party LAN is present Note: This field is read only if Intel® integrated LAN is disabled. See Table 2-2
	PHY Connectivity	10: PHY on SMLink0	10: PHY Connectivity = Intel® LAN is present 00: No PHY Connected (default) = Third-party LAN is present only Note: This field is read only if Intel® integrated LAN is disabled. See Table 2-2

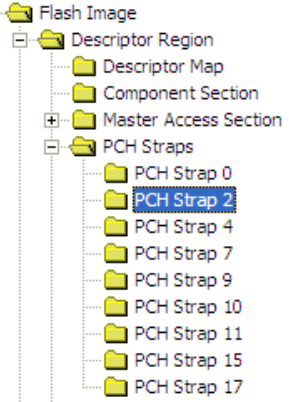
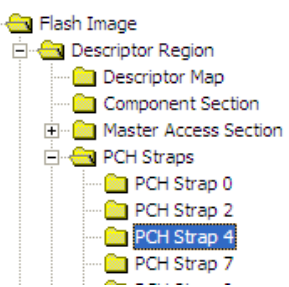
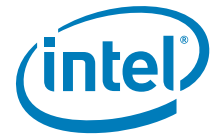

Table 2-17. Flash Image | Descriptor Region | PCH Straps | PCH Strap 7

Location	Parameter	CRB Set To	Settings for Any Platform
Follow navigation tree below: <ul style="list-style-type: none"> • Select the Flash Image tab. • Select Flash Image Descriptor Region PCH Straps PCH Strap 7 • Set the parameters in the PCH Strap 7 	Intel® ME SMBus Subsystem Vendor & Device ID for ASF2	0x00000000	Treat as reserved.



Table 2-18. Flash Image | Descriptor Region | PCH Straps | PCH Strap 9

Location	Parameter	CRB Set To	Settings for Any Platform								
Follow navigation tree below: <ul style="list-style-type: none"> Select the Flash Image tab Select Flash Image Descriptor Region PCH Straps PCH Strap 9 Set the parameters in the PCH Strap 9 	Yellow means custom settings may be required.										
	PCHHOT# or SML1ALERT# Select	SML1ALERT#	This strap determines the native mode operation of GPIO74. PCHHOT# is used to indicate the PCH temperature out of bounds condition to an external agent such as BMC or EC, when PCH temperature is greater than value programmed by BIOS. SML1ALERT# allows the ME SMBus controller to alert an external controller connected to the SMLink interface when it wants to talk to the external controller.								
	Subtractive Decode Agent Enable	true	true = A PCI Bridge chip is connected to the PCH false (default) = A PCI Bridge chip is not connected to the PCH <i>Note:</i> Please consult the target hardware designer to determine this setting								
	Intel® PHY Over PCI Express Enable (PHY_PCIE_EN)	true	true (default) = Intel® LAN is present false = Third-party LAN is present								
	Intel® PHY PCIe Port Select (PHY_PCIEPORTSEL)	101:Port 6	Only necessary if Intel® LAN is present. 101 = Third-party LAN is present (don't care setting) <i>Note:</i> This field is read only if Intel® integrated LAN is disabled. See Table 2-2								
			<table border="0"> <tr> <td>000 = Port 1</td> <td>100 = Port 5</td> </tr> <tr> <td>001 = Port 2</td> <td>101 = Port 6</td> </tr> <tr> <td>010 = Port 3</td> <td>110 = Port 7</td> </tr> <tr> <td>011 = Port 4</td> <td>111 = Port 8</td> </tr> <tr> <td colspan="2">Default is 101.</td> </tr> </table>	000 = Port 1	100 = Port 5	001 = Port 2	101 = Port 6	010 = Port 3	110 = Port 7	011 = Port 4	111 = Port 8
	000 = Port 1	100 = Port 5									
	001 = Port 2	101 = Port 6									
	010 = Port 3	110 = Port 7									
	011 = Port 4	111 = Port 8									
Default is 101 .											
Chipset Config	true	Must be set to true (1b).									
DMI Lane Reversal	false	<i>Note:</i> Please consult the target hardware designer to determine this setting When using Small Form Factor CRB platforms (SKU QS77 and UM77), Set this value to true .									
PCIe Lane Reversal 2	false	This parameter must reflect platform topology. <i>Note:</i> This parameter can only be set to true if PCIe Port configuration 2 is set to 1x4 .									
PCIe Lane Reversal 1	false	This parameter must reflect platform topology. <i>Note:</i> This parameter can only be set to true if PCIe Port configuration 1 is set to 1x4 .									
PCIe Port Configuration 2	00: 4x1 Ports 5-8 (x1)	<i>Note:</i> Please consult the target hardware designer to determine this setting									
PCIe Port Configuration 1	00: 4x1 Ports 1-4 (x1)	<i>Note:</i> Please consult the target hardware designer to determine this setting									

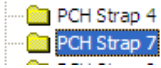
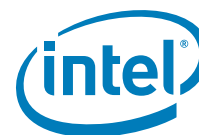

Table 2-19. Flash Image | Descriptor Region | PCH Straps | PCH Strap 10

Location	Parameter	CRB Set To	Settings for Any Platform
Follow navigation tree below: <ul style="list-style-type: none"> Select the Flash Image tab Select Flash Image Descriptor Region PCH Straps PCH Strap 10 Set the parameters in the PCH Strap 10 section as shown 	Yellow means custom settings may be required.		
	ME boot from Flash	false (grayed out)	false (default) = No ME Region binary loaded, or ME Region binary does not contain ME ROM bypass image Note: On B0 and later PCH stepping parts this setting should be set to 'false'
	Reserved	false	This value must be set to 'false'
	ME Debug SMBus Emergency Mode Enable	false	Note: This option should not be enabled. Treat as Reserved.
	ME Debug SMBus Emergency Mode Address	0x00	0x38 = Recommended SMBus address for ME Debug Set for non-production/debug platforms. 0x00 = Set for production platforms.
	ICC Boot Profile	0	Specifies which clock control parameter set is to be used by the final generated SPI Flash binary image by the target platform at boot time. SPI Flash binary images across multiple board designs are expected to contain the same block of clock control parameters, up to 8 sets total. The 'Record #' refers to records created under the Configuration Tab, Flash Image ME Region Configuration ICC Data . Default is 0 .
	ME Reset Capture on CL_RST1#	false	Determines if ME reset assert/de-assert can be observed on PCH pin CL_RST1#. true = ME reset assert/de-assert can be observed on PCH pin CL_RST1# false = CL_RST1# usage is available as per <i>Intel® 7 Series / 216 Chipset Family EDS</i>
	ICC Boot Profile Selected By Soft Strap	true	Specifies if the ICC Boot Profile is selected by Soft Strap or controlled by BIOS.
	Deep Sx Enable	false	true (default) = Platform HW configuration supports DSW rail and entry into Deep S3, S4 / S5. false = For platform that do not support DSW rail or Deep S3, S4 / S5. Note: Please consult with the target hardware designer to determine this setting. Note: See Section 5.3 – for details on configuring this option.
	ME Debug LAN Emergency Mode	false	true = Enables ME Debug LAN Emergency Mode logging. Set for non-production/debug platforms. false (default) = Set for production platforms



Table 2-20. Flash Image | Descriptor Region | PCH Straps | PCH Strap 11

Location	Parameter	CRB Set To	Settings for Any Platform
<p>Follow navigation tree below:</p> <ul style="list-style-type: none"> Select the Flash Image tab Select Flash Image Descriptor Region PCH Straps PCH Strap 11 Set the parameters in the PCH Strap 11 section as shown 	<p>Yellow means custom settings may be required.</p>		
	<p>SMLink1 I2C Target Address Enable</p>	<p>CRB uses true</p>	<p>true (default) = Enable EC/SIO/BMC to interact Thermal Reporting feature over SMLink1 false = Platform has no EC/SIO/BMC on SMLink1</p>
	<p>SMLink1 I2C Target Address</p>	<p>CRB uses 0x4C</p>	<p>This parameter defines a write address for PCH over SMLink1. Set this to an address supported by EC/SIO/BMC hardware. Note that PCH/Intel® ME acts as slave on SMLink and EC/SIO/BMC acts as master. 0x4C (default) = PCH SMBus write address for EC on mobile CRB 0x00 = Platform has no EC/SIO/BMC on SMLink1</p>
	<p>SMLink1 GP Target Address Enable</p>	<p>CRB uses true</p>	<p>true (default) = Enable EC/SIO/BMC to interact Thermal Reporting feature over SMLink1 false = Platform has no EC/SIO/BMC on SMLink1</p>
	<p>SMLink1 GP Target Address</p>	<p>CRB uses 0x4B</p>	<p>This parameter defines a read address for PCH over SMLink1. Set this to an address supported by EC/SIO/BMC hardware. Note that PCH/Intel® ME acts as slave on SMLink and EC/SIO/BMC acts as master. 0x4B (default) = PCH SMBus read address for EC on mobile CRB 0x00 = Platform has no EC/SIO/BMC on SMLink1</p>

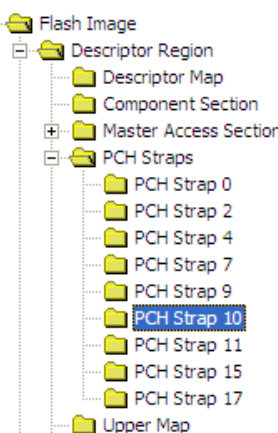
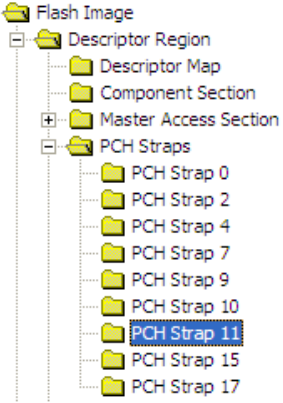
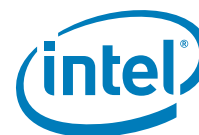

Table 2-21. Flash Image | Descriptor Region | PCH Straps | PCH Strap 15

Location	Parameter	CRB Set To	Settings for Any Platform
Follow navigation tree below: <ul style="list-style-type: none"> Select Flash Image Descriptor Region PCH Straps PCH Strap 15 Set the parameters in the PCH Strap 15 section as shown 	Yellow means custom settings may be required.		
	SLP_LAN#/GPIO29 Select	false	true = Enables GPIO29 and disables SLP_LAN# functionality. false = Set to false to use have GPIO behave as SLP_LAN#. Note: This field is read only if Intel® integrated LAN is disabled. See Table 2-2 .
	SMLink1 Thermal Reporting Select	Desktop false Mobile true false	false = Intel® ME FW will collect temperature from the processor, PCH and DIMMs. It will be available for polling on SMLink1. Note: <u>ME Thermal Reporting:</u> Advantage = Does not require PECCI capability in EC. Disadvantage = no real time temperature alert level control, and no dynamic Sandy Bridge / Ivy Bridge CPU Turbo controls. <ul style="list-style-type: none"> — SMLink Thermal Reporting Select = false (default) — PECCI from Sandy Bridge / Ivy Bridge processor is connected to PCH — BIOS sets Thermal Reporting Control (TRC) MMIO register at TBARB+1Ah to enable ME reporting of processor, PCH, and DIMM temperatures (as appropriate) — ME thermal reporting PCI device should be enabled for proper interaction with EC, SIO, BMC, or equivalent fan control logic true = PCH temperature ONLY(1 byte of data) will be available for polling out on SMLink1. Processor and DIMMs temperature monitoring will require an external device. Note: <u>Platform based Thermal Reporting:</u> Advantage = allows full dynamic Sandy Bridge / Ivy Bridge Turbo control. Disadvantage = Requires EC/BMC with PECCI capability. <ul style="list-style-type: none"> — SMLink Thermal Reporting Select = true — PECCI from Sandy Bridge / Ivy Bridge processor is connected direct to EC, SIO, BMC, or equivalent fan control logic — BIOS sets Thermal Reporting Control (TRC) MMIO register at TBARB+1Ah = 0x0, disabling ME reporting of processor, PCH, and DIMM temperatures — ME thermal reporting PCI device should be disabled
	Intel® Integrated LAN Enable	true	true = Intel® LAN is enabled false = Intel® LAN is disabled Note: This field is read only if Intel® integrated LAN is disabled. See Table 2-2 .
Reserved0	false	Treat as reserved.	



Table 2-22. Flash Image | Descriptor Region | PCH Straps | PCH Strap 17

Location	Parameter	CRB Set To	Settings for Any Platform
Follow navigation tree below: <ul style="list-style-type: none"> Select Flash Image Descriptor Region PCH Straps PCH Strap 17 Set the parameters in the PCH Strap 17 section as shown 	Yellow means custom settings may be required.		
	BTM/FCIM Select	Full Clock Integrated Mode	If PCH clock boot mode is specified by soft strap then this parameter specifies whether the PCH clocks boot in Full Clock Integrated Mode (FCIM) or Buffer Through Mode (BTM). NOTE: Buffer Through Mode (BTM) is NOT POR mode supported by Intel® 7 Series/ C216 Chipset Family and it will not be validated by Intel®.

2.5 Configure PCH Silicon SKU

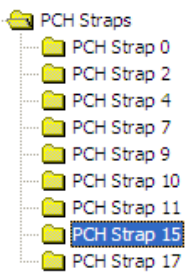
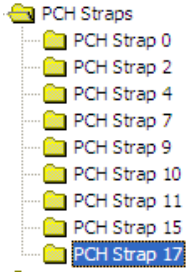
Use the **SKU Manager Combo Box** to select the appropriate platform type for your specific chipset.

For Intel® ME 1.5MB FW, the only valid choices are:

- 7 Series Chipset
 - Intel® Z77 Express Chipset
 - Intel® Z75 Express Chipset
 - Intel® H77 Express Chipset
 - Mobile Intel® QS77 Express Chipset
 - Mobile Intel® HM70 Express Chipset
 - Mobile Intel® HM77 Express Chipset
 - Mobile Intel® HM76 Express Chipset
 - Mobile Intel® HM75 Express Chipset
 - Mobile Intel® UM77 Express Chipset
- Intel® 6 Series Chipset
 - Intel® P67 Express Chipset
 - Intel® H67 Express Chipset
 - Intel® H61 Express Chipset
 - Intel® Z68 Express Chipset
 - Mobile Intel® HM65 Express Chipset

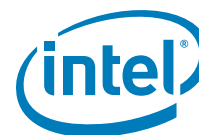
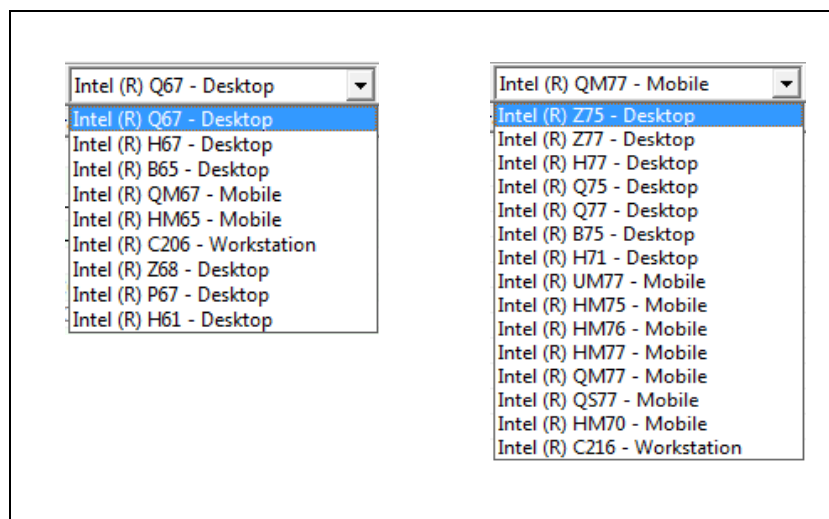

Figure 2-4. SKU Manager Combo Box



When a PCH SKU is selected in FITC, Super SKU PCH silicon will then behave as if it were the selected Production SKU PCH silicon from Intel®ME FW perspective. The SKU Manager selection option has no effect on Production SKU PCH silicon. Features cannot be enabled on such SKUs that do not support them.

Note: The SKU Manager combination box changes the LPC device ID which is used to identify the PCH. If there are issues with drivers, host software, or BIOS that do not recognize the PCH, then select the appropriate SKU with Super SKU DID.

Note: P67 must use a discrete graphics solution. Undesired behavior such as failure to boot may result if using integrated graphics.

Note: For more information see [Section 5.4](#) for Intel®ME FW features listed by Production SKU PCH silicon.

Note: Sections of FITC other than the **Features Supported** folder under **Flash Image ME | Region | Configuration** will not reflect what is disabled for the selected PCH silicon SKU and/or ME FW binary.

2.6 Intel®ME FW Feature Configuration

Note: Do not load or change any parameters in the Configuration tab until you load an Intel®ME Region binary (see [Table 2-3](#)).



2.6.1 Firmware Features and Capabilities

Table 2-23. Flash Image | ME Region | Configuration | ME (Sheet 1 of 2)

Location	Parameter	CRB Set To	Settings for Any Platform
Follow navigation tree below: <ul style="list-style-type: none"> Select Flash Image ME Region Configuration ME Set the parameters in the ME section as shown 	Yellow means custom settings may be required.		
	FW Update OEM ID	00000000-0000-0000-0000-000000000000	This field provides the ability to target FWUpdate (FWUpdLcl.exe) by Platform OEM. This ID will make sure that customers can only update a platform with an image coming from the platform OEM. If set to an all zeros, then any input is valid when doing a firmware update.
	LAN Power Well Config	3	Intel® LAN power configuration selection: 0 = Core Well (SLP_S3#) 1 = Sus Well (RSMRST#) 2 = ME Well (SLP_M#) 3 (recommended) = SLP_LAN#
	WLAN Power Well Config	0x80	0x80 = Disabled (default) 0x82 = Sus Well 0x83 = ME Well 0x85 = WLAN Power Controlled via SLP_M# SLP_ME_CSW_DEV# For Mobile platforms using wireless manageability you will need to set one of the following WLAN Power Well Config options. Strap 10 -> Deep Sx Enable set to 'false': 0x84 = WLAN Power Controlled via SLP_M# SPDA - See Table 2-19 Strap 10 -> Deep Sx Enable set to 'true': 0x85 = WLAN Power Controlled via SLP_M# SLP_ME_CSW_DEV# - See Table 2-19 For Desktop platforms using the Intel® Centrino® Advanced-N 6205 (Taylor Peak 2x2) for wireless manageability set the WLAN Power Well Config option to 0x85 . Note: For Workstation platforms this setting will be readonly and set to the default of 0x80 .
	M3 Power Rails Availability	true	true = M3 power rails designed on platform (ME is powered by standby) false = M3 power rails not designed on platform (ME is powered by core) Note: This field is read only if Power package 2 supported is enabled. Note: Please consult the target hardware designer to determine this setting.
	Host ME Region Flash Protection Override	true	false = Disable HMFPRO LOCK and HMFPRO ENABLE Intel® MEI messages for BIOS-based FW Update true = Enable this capability Note: Please consult the target BIOS developer to determine this setting.
Sub System Vendor ID	0x0000	Treat as reserved.	

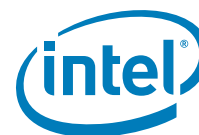

Table 2-23. Flash Image | ME Region | Configuration | ME (Sheet 2 of 2)

Location	Parameter	CRB Set To	Settings for Any Platform
	PROC_MISSING	No onboard glue logic	Only set if there is glue logic present on the board to enable if the processor is missing. Note: This field is read only if a Mobile SKU is selected in the SKU Manager pull down box. Note: Please consult the target hardware designer to determine this setting.
	Processor Emulation	No EmulationNo Emulation	Set this parameter to the type of processor that the target system will use during production. This field will emulate that processor class for pre-production silicon.
	OEM Tag	0x00000000	This value allows OEMs to set a unique number value in their firmware images to allow for easier identification.
	Hide FW Update Control	false	This option determines if the MEBx FW Update is visible or hidden from end users. 'false' - The MEBx FW update option will be visible to end users. 'true' - The MEBx FW update option will not be visible to the end user.
	Debug Si Features	0x00000000	Allows OEM Control to enable FW features to assist with the debug of the platform. This control has no effect if used on production silicon. Bit 0: Disable time-out on BIOS HECI messaging Bit 1: Disable FW watchdog timer
	Prod Si Features	0x00000000	Allow OEM Control to enable FW features to assist with the production platform. Bit 1: Disable FW watchdog timer
	M3 Autotest Enabled	false	This enables Intel® ME FW M3 auto test during platform early boot. 'false' - The Intel® ME FW will not run M3 tests during first boot after platform image flash. 'true' - The Intel® ME FW will run M3 tests during first boot after platform image flash.
	Independent Firmware Recovery Enable	true	This option determines if Independent Firmware Recovery is enabled. 'false' - Independent Firmware Recovery is disabled in the firmware. 'true' - Independent Firmware Recovery is enabled in the firmware.



Table 2-24. Flash Image | ME Region | Configuration | Power Packages

Location	Parameter	CRB Set To	Settings for Any Platform
Follow navigation tree below: <ul style="list-style-type: none"> Select Flash Image ME Region Configuration Power Packages Set the parameters in the Power Packages section as shown 	Yellow means custom settings may be required.		
	Power Pkg 2 Supported (Desktop: ON in S0, ME Wake in S3, S4-5)	false	Intel® false = Set for all platforms (not supported on 1.5MB FW)
	Default Power Package	1	Select the default Power Package from the available packages. Set to 1 for all platforms. Note: The ON in S0 package is automatically selected as default in the base firmware binary.

Table 2-25. Flash Image | ME Region | Configuration | Features Supported

Location	Parameter	CRB Set To	Settings for Any Platform
Follow navigation tree below: <ul style="list-style-type: none"> Select Flash Image ME Region Configuration Features Supported Set the parameters in the Features Supported section as shown 	Yellow means custom settings may be required.		
	Enable Intel® Standard Manageability; Disable Intel® AMT	Yes	Note: Setting any of these options to 'Yes' will permanently disable that specific feature. Once the feature is disabled in this manner only re-Flashing the ME region can re-enable the feature. Fields are read only if the feature is not supported by respective PCH SKU selected by PCH SKU pull down (see Section 2.1).
	Intel® Manageability Application Permanently Disabled?	Yes	
	PAVP Permanently Disabled	No	
	KVM Permanently Disabled?	Yes	
	TLS Permanently Disabled?	No	
	Intel® Anti-Theft Technology Permanently disabled	No	
	Intel® ME Network Service Permanently disabled	No	
	Service Advertisement and Discovery Permanently Disabled	Yes	
	Intel® Manageability Application Enable/Disable	Disabled	
Note: The Feature supported settings shown above are an example.			

Since 1.5MB FW does not support “Manageability Application” when users select **Flash Image | ME Region | Configuration | Manageability Application**, the following Warning message will be displayed.

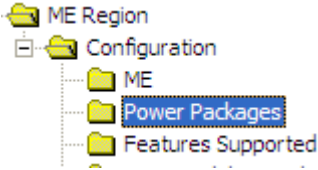
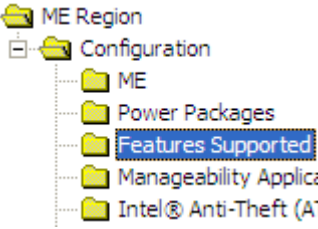

Figure 2-5. Manageability Application Warning

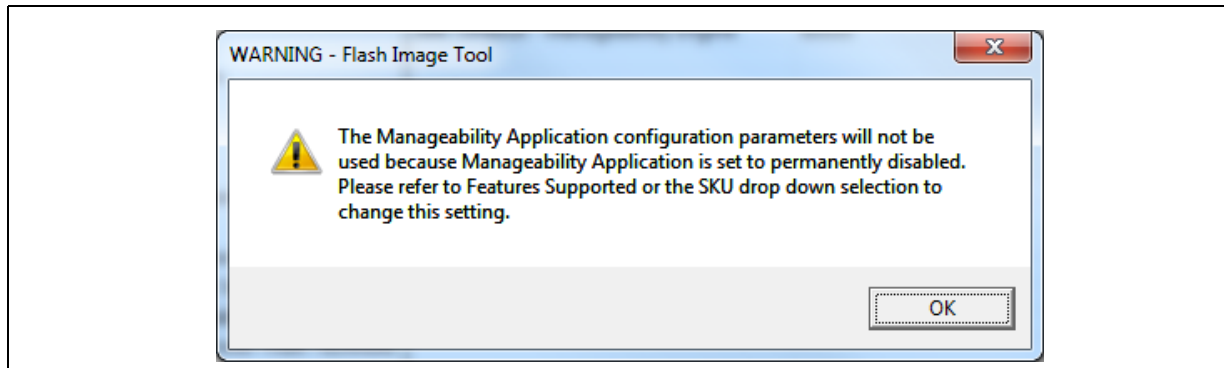

Table 2-26. Flash Image | ME Region | Configuration | Intel® Anti-Theft Technology

Location	Parameter	CRB Set To	Settings for Any Platform
Follow navigation tree below: <ul style="list-style-type: none"> Select Flash Image ME Region Configuration Intel® Anti-Theft Technology Set the parameters in the Intel® Anti-Theft Technology section as shown ME Power Packages Features Supported Manageability Application Intel (R) Anti-Theft Technology ME Debug Event Service Setup and Configuration ICC Data	Yellow means custom settings may be required.		
	Allow Unsigned Assert Stolen	false	Treat as reserved.
	Intel(R) Anti-Theft BIOS Recovery Timer	Disabled	This timer will enable a 30 minute window to allow a firmware/BIOS reflash before the system is powered down.



Table 2-26. Flash Image | ME Region | Configuration | Intel® Anti-Theft Technology

Location	Parameter	CRB Set To	Settings for Any Platform
	Flash Protection Override Policy Hard	Allowed When AT Not Provisioned	<p>This option determines if the ME will enter a disabled state to allow full SPI device re-flashing when the manufacturing override jumper (HMFPRO) is set.</p> <p>Always Allowed - Full SPI re-flash will always be allowed regardless of Intel® AT enrollment state.</p> <p>Allowed When AT Not Provisioned - Full SPI re-flash allowed if Intel® AT has not been enrolled.</p>
	Flash Protection Override Policy Soft	Allowed When AT Not Provisioned	<p>This option determines if the ME will enter a disabled state via BIOS based MEI messages and allow ME only region re-flash.</p> <p>Always Allowed - Intel® ME region re-flash will always be allowed regardless of Intel® AT enrollment state.</p> <p>Allowed When AT Not Provisioned - Intel® ME region re-flash allowed if Intel® AT has not been enrolled.</p>

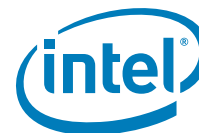

Table 2-27. Flash Image | ME Region | Configuration | ME Debug Event Service

Location	Parameter	ME Debug Enabled SPI Critical Logging* (FITC Default)	Full ME Debug Enabled	Settings for Any Platform																																																																								
<p>Follow navigation tree below:</p> <ul style="list-style-type: none"> Select Flash Image ME Region Configuration ME Debug Event Service Set the parameters in the ME Debug Event Service section as shown  <table border="1" data-bbox="194 987 584 1312"> <thead> <tr> <th>Parameter</th> <th>Value</th> </tr> </thead> <tbody> <tr><td>Error Filter</td><td>All</td></tr> <tr><td>Logging Interface - Network</td><td>false</td></tr> <tr><td>Logging Interface - SMBus</td><td>true</td></tr> <tr><td>Logging Interface - Flash</td><td>false</td></tr> <tr><td>Logging Interface - PRAM</td><td>false</td></tr> <tr><td>Buffer Size</td><td>24</td></tr> <tr><td>Buffer Mode</td><td>Buffered</td></tr> <tr><td>Source IP Address</td><td>10.2.0.2</td></tr> <tr><td>Destination IP Address</td><td>10.2.0.255</td></tr> <tr><td>Destination MAC Address</td><td>0C FF 17 22 FF 2D</td></tr> <tr><td>Slave Address Enable</td><td>true</td></tr> <tr><td>Slave Address</td><td>0x56</td></tr> <tr><td>Event Filters</td><td>Click To Edit</td></tr> </tbody> </table> <p>Basic Filter configuration:</p> <table border="1" data-bbox="178 1333 584 1417"> <tbody> <tr><td>Filter Group 1</td><td>0x00000001</td></tr> <tr><td>Filter Group 5</td><td>0x00000003</td></tr> <tr><td>Filter Group 6</td><td>0x000F0000</td></tr> <tr><td>Filter Group 70</td><td>0x00000001</td></tr> </tbody> </table> <p>Advanced Filter configuration (LAN):</p> <table border="1" data-bbox="178 1459 584 1564"> <tbody> <tr><td>Filter Group 1</td><td>0x00000001</td></tr> <tr><td>Filter Group 4</td><td>0x000003F6</td></tr> <tr><td>Filter Group 5</td><td>0x00000003</td></tr> <tr><td>Filter Group 6</td><td>0x000F0000</td></tr> <tr><td>Filter Group 70</td><td>0x00000001</td></tr> </tbody> </table> <p>Advanced Filter configuration (SMBus):</p> <table border="1" data-bbox="178 1606 584 1711"> <tbody> <tr><td>Filter Group 1</td><td>0x00000001</td></tr> <tr><td>Filter Group 4</td><td>0x000003F6</td></tr> <tr><td>Filter Group 5</td><td>0x00000003</td></tr> <tr><td>Filter Group 6</td><td>0x000F0000</td></tr> <tr><td>Filter Group 70</td><td>0x00000001</td></tr> </tbody> </table>	Parameter	Value	Error Filter	All	Logging Interface - Network	false	Logging Interface - SMBus	true	Logging Interface - Flash	false	Logging Interface - PRAM	false	Buffer Size	24	Buffer Mode	Buffered	Source IP Address	10.2.0.2	Destination IP Address	10.2.0.255	Destination MAC Address	0C FF 17 22 FF 2D	Slave Address Enable	true	Slave Address	0x56	Event Filters	Click To Edit	Filter Group 1	0x00000001	Filter Group 5	0x00000003	Filter Group 6	0x000F0000	Filter Group 70	0x00000001	Filter Group 1	0x00000001	Filter Group 4	0x000003F6	Filter Group 5	0x00000003	Filter Group 6	0x000F0000	Filter Group 70	0x00000001	Filter Group 1	0x00000001	Filter Group 4	0x000003F6	Filter Group 5	0x00000003	Filter Group 6	0x000F0000	Filter Group 70	0x00000001	<p>Green means custom settings may be required (for enabling ME Debug only)</p> <p>Error Filter</p> <p>Logging Interface - Network</p> <p>Logging Interface - SMBus</p> <p>Logging Interface - Flash</p> <p>Logging Interface - PRAM</p> <p>Buffer Size</p> <p>Buffer Mode</p> <p>Source IP Address</p> <p>Destination IP Address</p> <p>Destination MAC Address</p> <p>Slave Address Enable</p> <p>Slave Address</p> <p>Event Filters</p>	<p>Critical</p> <p>false</p> <p>false</p> <p>true</p> <p>false</p> <p>0</p> <p>Blocking</p> <p>10.2.0.2</p> <p>10.2.0.255</p> <p>0C FF 17 22 FF 2D</p> <p>false</p> <p>0x00</p> <p>Filter Group 1: 0x00000001 Filter Group 76: 0x000000FE</p> <p>All other values set to: 0x00000000</p>	<p>All</p> <p>true</p> <p>false</p> <p>false</p> <p>24</p> <p>Buffered</p> <p>10.2.0.2</p> <p>10.2.0.255</p> <p>0C FF 17 22 FF 2D</p> <p>true</p> <p>0x56</p> <p>Basic</p> <p>Filter Group 1: 0x00000001 Filter Group 5: 0x00000003 Filter Group 6: 0x000F0000 Filter Group 70: 0x00000001</p> <p>Advanced (Intel® LAN)</p> <p>Filter Group 1: 0x00000001 Filter Group 4: 0x000003F6 Filter Group 5: 0x00000003 Filter Group 6: 0x000F0000 Filter Group 70: 0x00000001</p> <p>Advanced (SMBus)</p> <p>Filter Group 1: 0x00000001 Filter Group 4: 0x000003F6 Filter Group 5: 0x00000003 Filter Group 6: 0x000F0000 Filter Group 70: 0x00000001</p>	<p>Set to true only for platforms with Intel® LAN.</p> <p>Can be set to true for platforms with no Intel® LAN. May also be set to true if ME Debug logging through SMBus is desired.</p> <p>Note: This should only be used with the Critical filter setting options from the first column (ME Debug Enabled SPI Logging).</p> <p>Default is 0.</p> <p>Note: Delayed Flush is not supported.</p> <p>Note: Buffered mode should never be used when using SPI logging.</p> <p>This is the MAC address of the SUT.</p> <p>Default is 0x56.</p> <table border="1" data-bbox="1169 1155 1469 1365"> <thead> <tr> <th>Event Filter Groups</th> <th>Name of Event Filter Group</th> </tr> </thead> <tbody> <tr><td>1</td><td>CheckPoint</td></tr> <tr><td>4</td><td>Loader</td></tr> <tr><td>5</td><td>Power Management</td></tr> <tr><td>6</td><td>Thermal Reporting</td></tr> <tr><td>70</td><td>HECI</td></tr> <tr><td>74</td><td>MBP</td></tr> <tr><td>75</td><td>BIOS Debug</td></tr> </tbody> </table> <p>Note: To enable Filter groups 74 and 75 add a 1 value.</p>	Event Filter Groups	Name of Event Filter Group	1	CheckPoint	4	Loader	5	Power Management	6	Thermal Reporting	70	HECI	74	MBP	75	BIOS Debug
	Parameter	Value																																																																										
	Error Filter	All																																																																										
	Logging Interface - Network	false																																																																										
	Logging Interface - SMBus	true																																																																										
	Logging Interface - Flash	false																																																																										
	Logging Interface - PRAM	false																																																																										
	Buffer Size	24																																																																										
	Buffer Mode	Buffered																																																																										
	Source IP Address	10.2.0.2																																																																										
	Destination IP Address	10.2.0.255																																																																										
	Destination MAC Address	0C FF 17 22 FF 2D																																																																										
	Slave Address Enable	true																																																																										
	Slave Address	0x56																																																																										
	Event Filters	Click To Edit																																																																										
Filter Group 1	0x00000001																																																																											
Filter Group 5	0x00000003																																																																											
Filter Group 6	0x000F0000																																																																											
Filter Group 70	0x00000001																																																																											
Filter Group 1	0x00000001																																																																											
Filter Group 4	0x000003F6																																																																											
Filter Group 5	0x00000003																																																																											
Filter Group 6	0x000F0000																																																																											
Filter Group 70	0x00000001																																																																											
Filter Group 1	0x00000001																																																																											
Filter Group 4	0x000003F6																																																																											
Filter Group 5	0x00000003																																																																											
Filter Group 6	0x000F0000																																																																											
Filter Group 70	0x00000001																																																																											
Event Filter Groups	Name of Event Filter Group																																																																											
1	CheckPoint																																																																											
4	Loader																																																																											
5	Power Management																																																																											
6	Thermal Reporting																																																																											
70	HECI																																																																											
74	MBP																																																																											
75	BIOS Debug																																																																											



Table 2-28. Flash Image | ME Region | Configuration | Setup and Configuration

Location	Parameter	CRB Set To	Settings for Any Platform
Follow navigation tree below: <ul style="list-style-type: none"> • Select Flash Image ME Region Configuration Setup and Configuration • Set the parameters in the Setup and Configuration section as shown 	Yellow means custom settings may be required.		
	ODM ID used by Intel(R) Services	0x00000000	These fields are used by Intel® Services. Intel® Identity Protection Technology (Intel® IPT) use ODM ID field only (for platform identification between the OEM and the ISBV).
	System Integrator ID used by Intel(R) Services	0x00000000	
	Reserved ID used by Intel(R) Services	0x00000000	
	MCTP static EIDs	0x920030	Defines the ME 8 bit MCTP endpoint IDs for Each SMBus segment. Only bits 0-7 are supported to be modified. Bits 8-23 must be left to 0x9200
	MCTP Info 3G	0x02	This field must be set to the 7-bit SMBus address of the 3G NIC. Only supported if using Intel® Anti-Theft Technology with a 3G NIC
	Permit Period Timer Resolution	Days	Treat as reserved.
	PKI DNS Suffix	Leave Blank	Treat as reserved.
	OEM Default Certificate Active	false	Treat as reserved.
	OEM Default Certificate Friendly Name	Leave Blank	Treat as reserved.
	OEM Default Certificate Stream	Leave Blank	Treat as reserved.
	OEM Default Certificate 2-5 Active	false	Treat as reserved.
	OEM Default Certificate 2-5 Friendly Name	Leave Blank	Treat as reserved.
	OEM Default Certificate 2-5 Stream	Leave Blank	Treat as reserved.
	OEM Customizable Certificate 1-3 Active	false	Treat as reserved.
OEM Customizable Certificate 1-3 Friendly Name	Leave Blank	Treat as reserved.	
OEM Customizable Certificate 1-3 Stream	Leave Blank	Treat as reserved.	

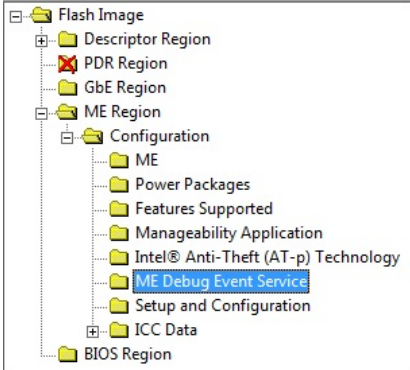
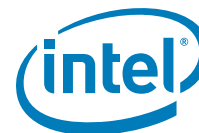

2.6.2 Clock Control Parameters

Table 2-29. Flash Image | ME Region | Configuration | ICC Data | ICC Profile 0 | FCIM/ BTM Specific Registers

Location	Parameter	CRB Set To	Settings for Any Platform																
<p>Follow navigation tree below:</p> <ul style="list-style-type: none"> On the navigation tree to the left, select the Flash Image ME Region Configuration ICC Data ICC Profile 0 FCIM/BTM Specific Registers Set the parameters in the FCIM/BTM Specific Registers section as shown in the table below <p>Note: Do not switch between FCIM and BTM defaults manually. Always use BTM/FCIM Select parameter under Flash Image Descriptor Region PCH Straps PCH Strap 17 to switch between Full Clock Integration Mode and Buffered Through Mode.</p>  <table border="1" data-bbox="235 1459 544 1669"> <thead> <tr> <th>Parameter</th> <th>Value</th> </tr> </thead> <tbody> <tr> <td>CSS</td> <td>0x00011A33</td> </tr> <tr> <td>SSS</td> <td>0x00033733</td> </tr> <tr> <td>PLLRCSS</td> <td>0x00088CBF</td> </tr> <tr> <td>PLLEN</td> <td>0x0000000C</td> </tr> <tr> <td>IBEN</td> <td>0x0000002F</td> </tr> <tr> <td>DIVEN</td> <td>0x000005EB</td> </tr> <tr> <td>SSCCTL</td> <td>0x00010000</td> </tr> </tbody> </table>	Parameter	Value	CSS	0x00011A33	SSS	0x00033733	PLLRCSS	0x00088CBF	PLLEN	0x0000000C	IBEN	0x0000002F	DIVEN	0x000005EB	SSCCTL	0x00010000	<p style="text-align: center;">Green means custom settings may be required (for overclocking only).</p> <p>Note: BCLK overclocking requires the PCH SKU to support BCLK overclocking. See Section B.3.22 for detail on PCH SKU that support BCLK overclocking. Note that BCLK overclocking places the platform in an unsupported configuration and/or operational state and can result in platform instability, physical damage, and data loss. BCLK overclocking margins are not guaranteed or supported.</p>		
	Parameter	Value																	
	CSS	0x00011A33																	
	SSS	0x00033733																	
	PLLRCSS	0x00088CBF																	
	PLLEN	0x0000000C																	
	IBEN	0x0000002F																	
	DIVEN	0x000005EB																	
SSCCTL	0x00010000																		
Clock Source Select		FCIM: 0x0001_1A33	This parameter controls clock source selection for non-PCI Express* clocks. See Section B.3.1 for more information on this parameter. 0x0001_1A34 = FCIM overclocking																
SRC Source Select		FCIM: 0x0003_3733 BTM: 0x0000_0000	This parameter controls clock source selection for PCI Express* clocks. See Section B.3.2 for more information on this parameter. 0x0013_3744 = FCIM overclocking																
PLL Reference Clock Select		FCIM: 0x0008_8CBF BTM: 0x0000_0878	This parameter controls reference clock selection for PLLs. See Section B.3.3 for more information on this parameter. 0x000A_8CBE = FCIM overclocking																
PLL Enable		FCIM: 0x8000_000C	This parameter controls PLL enables. See Section B.3.4 for more information on this parameter. Recommend keeping defaults for bring up with Intel® ME FW.																
Input Buffer Enable		FCIM: 0x0000_002F BTM: 0x8000_000C	This parameter controls enabling of input buffers. See Section B.3.9 for more information on this parameter. Recommend keeping defaults for bring up with Intel® ME FW.																
Divider Enable		FCIM: 0x0000_05EB BTM: 0x0000_0009	This parameter controls enabling of divider blocks. See Section B.3.10 for more information on this parameter. 0x0000_05FF = FCIM overclocking Note: PCH use the 14.31818Mhz Fraction divisor to provide clock for PCH internal legacy 8254, and PM timers. Turning off the 14.31818Mhz Fraction divisor will turn off clock to the PCH legacy 8254, and PM timers. The 14.31818Mhz Fraction divisor should NOT be turn off even if it is not used externally.																
SSC Control		FCIM: 0x0001_0000 BTM: 0x0000_0000	This parameter controls spread spectrum modulation capability of SSC blocks. See Section B.3.15 for more information on this parameter. 0x0000_0000 = FCIM overclocking																



Table 2-30. Flash Image | ME Region | Configuration | ICC Data | ICC Profile 0 | ICC Registers

Location	Parameter	CRB Set To	Settings for Any Platform																																
<p>Follow navigation tree below:</p> <ul style="list-style-type: none"> On the navigation tree to the left, select the Flash Image ME Region Configuration ICC Data ICC Profile 0 ICC Registers Set the parameters in the ICC Registers section as shown in the table below <p>Note: BTM/FCIM Select parameter under Flash Image Descriptor Region PCH Straps PCH Strap 17 has <u>no</u> effect on values in this section.</p>  <table border="1" data-bbox="219 1270 576 1585"> <thead> <tr> <th>Parameter</th> <th>Value</th> </tr> </thead> <tbody> <tr><td>FCSS</td><td>0x00000232</td></tr> <tr><td>OCKEN</td><td>0x1FFF0F8F</td></tr> <tr><td>Output Clock Allow Enable/Disable Bef...</td><td>0x1FFF0F8F</td></tr> <tr><td>Output Clock Allow Enable/Disable Aft...</td><td>0x1FFF0F8F</td></tr> <tr><td>PM1</td><td>0x0000001F</td></tr> <tr><td>PM2</td><td>0x00000000</td></tr> <tr><td>SEBP1</td><td>0x00009999</td></tr> <tr><td>SEBP2</td><td>0x00009999</td></tr> <tr><td>DIVSET</td><td>0x00455551</td></tr> <tr><td>SSC1PARMS</td><td>0x1270A428</td></tr> <tr><td>SSC2PARMS</td><td>0x12704C30</td></tr> <tr><td>SSC3PARMS</td><td>0x12704C30</td></tr> <tr><td>SSC4PARMS</td><td>0x1270A428</td></tr> <tr><td>PMSRCCLK1</td><td>0x76543210</td></tr> <tr><td>PMSRCCLK2</td><td>0x00000F98</td></tr> </tbody> </table>	Parameter	Value	FCSS	0x00000232	OCKEN	0x1FFF0F8F	Output Clock Allow Enable/Disable Bef...	0x1FFF0F8F	Output Clock Allow Enable/Disable Aft...	0x1FFF0F8F	PM1	0x0000001F	PM2	0x00000000	SEBP1	0x00009999	SEBP2	0x00009999	DIVSET	0x00455551	SSC1PARMS	0x1270A428	SSC2PARMS	0x12704C30	SSC3PARMS	0x12704C30	SSC4PARMS	0x1270A428	PMSRCCLK1	0x76543210	PMSRCCLK2	0x00000F98	<p>Yellow means custom settings may be required.</p>		
	Parameter	Value																																	
	FCSS	0x00000232																																	
	OCKEN	0x1FFF0F8F																																	
Output Clock Allow Enable/Disable Bef...	0x1FFF0F8F																																		
Output Clock Allow Enable/Disable Aft...	0x1FFF0F8F																																		
PM1	0x0000001F																																		
PM2	0x00000000																																		
SEBP1	0x00009999																																		
SEBP2	0x00009999																																		
DIVSET	0x00455551																																		
SSC1PARMS	0x1270A428																																		
SSC2PARMS	0x12704C30																																		
SSC3PARMS	0x12704C30																																		
SSC4PARMS	0x1270A428																																		
PMSRCCLK1	0x76543210																																		
PMSRCCLK2	0x00000F98																																		
Flex Clock Source Select	0x0000_0232	This parameter controls muxing to select sources for Flex Clock outputs. Each nibble from most to least significant bit is for FLEX3:0. See Section B.3.3 for more information on this parameter. Note: 27 Mhz option is available in the tool, but is not extensively tested by Intel® and is not recommended for use. Recommend keeping defaults for bring up with Intel® ME FW.																																	
Output Clock Enable	0x1FFF_0F8F	This parameter controls enabling of output buffers. See Section B.3.8 for more information on this parameter. Recommend keeping defaults for bring up with Intel® ME FW.																																	
Output Clock Allow Enable/Disable Before POST	0x0DFF0F8F	This parameter controls allowing of enable/disable of output buffers before BIOS END_OF_POST Intel® MEI message. The structure of this parameter is identical to OCKEN parameter. See Section B.3.8 for more information on this parameter. Change to 0x0DFF0F8F to prevent DMI clock from being disabled by application running before POST. Default is 0x00FF_0F8F .																																	
Output Clock Allow Enable/Disable After POST	0x01FF0F8F	This parameter controls allowing of enable/disable of output buffers after BIOS END_OF_POST Intel® MEI message. The structure of this parameter is identical to OCKEN parameter. See Section B.3.8 for more information on this parameter. Change to 0x01FF0F8F to prevent DMI, PEG A, and PEG B clocks from being disabled by application running after POST. Default is 0x00FF_0F8F .																																	
PM1 - Power Management	0x0000_001F	This parameter controls power management features of clocks. See Section B.3.11 for more information on this parameter. Recommend keeping defaults for bring up with Intel® ME FW.																																	

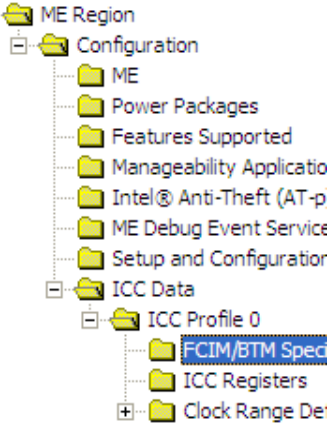
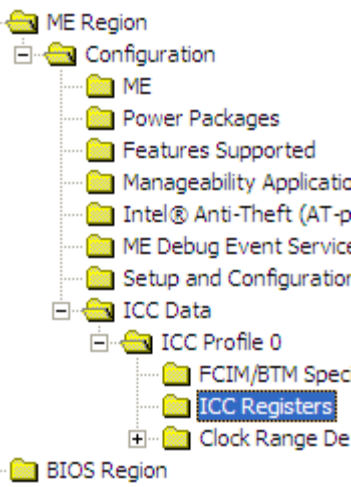
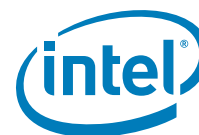

Table 2-30. Flash Image | ME Region | Configuration | ICC Data | ICC Profile 0 | ICC Registers

Location	Parameter	CRB Set To	Settings for Any Platform
	PM2 - Power Management	0x0000_0000	This parameter controls power management CLKRUN for PCI clocks. See Section B.3.12 for more information on this parameter.
	Yellow means custom settings may be required.		
	SEBP1	0x0000_9999	This parameter controls double/single load series resistance and slew rate for FLEX clocks. See Section B.3.13 for more information on this parameter. Recommend keeping defaults for bring up with Intel® ME FW.
	SEBP2	0x0009_9999	This parameter controls double/single load series resistance and slew rate for PCI clocks. See Section B.3.14 for more information on this parameter. Recommend keeping defaults for bring up with Intel® ME FW.
	DIVSET	0x0045_5551	Treat as reserved.
	PI12BiasParms	0x0888_0888	This is a Chipset Configuration (PCHCFG) parameter. 0x0000_0888 = FCIM overclocking
	SSC1PARMS	0x1270_A428	Treat as reserved.
	SSC2PARMS	0x1270_4C30	Note: For platform that support Wimax Friendly Clocking- change this registers setting to 0x1270_F418 otherwise treat this registers as reserved and use default value For more information on PCH SKU that support Wimax Friendly Clocking, see appendix B.3.22
	SSC3PARMS	0x1270_4C30	Treat as reserved.
	SSC4PARMS	0x1270_A428	Treat as reserved.
	SSC2OCPARMS	0x0000_0000	Note: or platform that support Wimax Friendly Clocking - change this registers setting to 0x0000_0300 otherwise treat this registers as reserved and use default value For more information on PCH SKU that support Wimax Friendly Clocking, see appendix B.3.22
	PMSRCCLK1	0x7654_3210	This parameter as signs dynamic CLKRO# control of SRC clocks. See Section B.3.16 for more information on this parameter. Recommend keeping defaults for bring up with Intel® ME FW.
	PMSRCCLK2	0x0000_0F98	This parameter as signs dynamic CLKRO# control of SRC clocks. See Section B.3.17 for more information on this parameter. Recommend keeping defaults for bring up with Intel® ME FW.



Table 2-31. Flash Image | ME Region | Configuration | ICC Data | ICC Profile 0 | Clock Range Definition Record 0 (Sheet 1 of 3)

Location	Section			Settings for Any Platform																		
<p>Follow navigation tree below:</p> <ul style="list-style-type: none"> On the navigation tree to the left, select the Flash Image ME Region Configuration ICC Data ICC Profile 0 Clock Range Definition Record 0 Set the parameters in the Clock Range Definition Record 0 section as shown in the table below <p>Note: ClockDivMin refers to minimum divider value which corresponds to <u>maximum</u> frequency output value. ClockDivMax refers to maximum divider value which corresponds to <u>minimum</u> frequency output value.</p> <p>Note: Changes are required only if overclocking, otherwise defaults may be used.</p>  <table border="1" data-bbox="219 1165 544 1344"> <thead> <tr> <th>Parameter</th> <th>Value</th> </tr> </thead> <tbody> <tr> <td>Clock Div Min</td> <td>0x0C00</td> </tr> <tr> <td>Clock Div Max</td> <td>0x0C06</td> </tr> <tr> <td>SSC Change Allowed Mask</td> <td>true</td> </tr> <tr> <td>SSC Spread Mode Control Up</td> <td>false</td> </tr> <tr> <td>SSC Spread Mode Control Center</td> <td>false</td> </tr> <tr> <td>SSC Spread Mode Control Down</td> <td>true</td> </tr> <tr> <td>SSC Spread Percent Max</td> <td>50</td> </tr> <tr> <td>Clock Usage</td> <td>0x000</td> </tr> </tbody> </table>	Parameter	Value	Clock Div Min	0x0C00	Clock Div Max	0x0C06	SSC Change Allowed Mask	true	SSC Spread Mode Control Up	false	SSC Spread Mode Control Center	false	SSC Spread Mode Control Down	true	SSC Spread Percent Max	50	Clock Usage	0x000	<p>Yellow means custom settings may be required.</p>			
	Parameter	Value																				
	Clock Div Min	0x0C00																				
	Clock Div Max	0x0C06																				
	SSC Change Allowed Mask	true																				
SSC Spread Mode Control Up	false																					
SSC Spread Mode Control Center	false																					
SSC Spread Mode Control Down	true																					
SSC Spread Percent Max	50																					
Clock Usage	0x000																					
<p>Green means custom settings may be required (for BCLK overclocking only).</p> <p>Note: BCLK overclocking requires the PCH SKU to support BCLK overclocking. See Section B.3.22 for detail on PCH SKU that support BCLK overclocking. Note that BCLK overclocking places the platform in an unsupported configuration and/or operational state and can result in platform instability, physical damage, and data loss. BCLK overclocking margins are not guaranteed or supported.</p>																						
	120/27 MHz Graphics Clock (DIV1-S)			Treat as reserved.																		
	Processor or Platform DMICLK (DIV2-S)			Parameters not shown may be treated as reserved.																		
	Parameter	CRB Set To	CRB OC Set To	Comments																		
	Clock Div Min	0x0C00	0x0400	<p>Recommended maximum clock divider frequency is 100.0 MHz (clock divider minimum = 0xC00).</p> <p>Change to 0x180 (800 MHz) if BCLK overclocking is being utilized. If the limit for BCLK overclocking is desired to be lower, use one of the following values:</p> <p>0x180 = 800 MHz 0x200 = 600 MHz 0x300 = 400 MHz 0x400 = 300 MHz 0x4CC = 250.1629 MHz 0x554 = 225.2199MHz 0x600 = 200 MHz 0x6DA = 175.1425 MHz 0x800 = 150 MHz 0x892 = 140.0182 MHz 0x93A = 130.0593 MHz 0xA00 = 120 MHz 0xAE8 = 110.0287 MHz 0xB6C = 105.0616 MHz</p>																		
	Clock Div Max	0x0C00	0x0C0E	<p>For Basic platform configuration, recommended minimum clock divider frequency is 100MHz clock divider maximum = 0xC00)</p> <p>For platform that support Wimax friendly clocking or overclocking, the recommended minimum clock divider frequency is 99.5463 MHz (clock divider maximum = 0xC0E).</p> <p>For more information on PCH SKU that support Wimax Friendly Clocking or overclocking, see appendix B.3.22</p>																		



Table 2-31. Flash Image | ME Region | Configuration | ICC Data | ICC Profile 0 | Clock Range Definition Record 0 (Sheet 2 of 3)

Location	Section		Settings for Any Platform
	SSC Change Allowed Mask	true	This determines if the SSC parameters of this clock resource can be controlled by the handled request record.
	SSC Spread Mode Control Up	false	
	SSC Spread Mode Control Center	false	
	SSC Spread Mode Control Down	true	
	SSC Spread Percent Max	50	
	Clock Usage	0x0DF	<div style="background-color: #00FF00; display: inline-block; padding: 2px;">0x007</div> Change to indicate processor/DMI (0x007) if overclocking is being utilized. Default is 0x0DF .
	Section		Settings for Any Platform

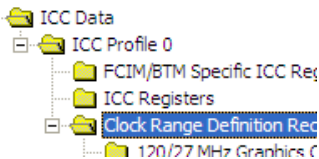

Table 2-31. Flash Image | ME Region | Configuration | ICC Data | ICC Profile 0 | Clock Range Definition Record 0 (Sheet 3 of 3)

Location	Section		Settings for Any Platform	
	PCH DMICLK (DIV3)		Make changes below only if overclocking. Parameters not shown may be treated as reserved.	
	Parameter	CRB Default	Comments	
	Clock Div Min	0x0C00	0x0C00	Recommended maximum clock divider frequency is 100.0 MHz (clock divider minimum = 0xC00).
	Clock Div Max	0x0C00	0x0C0E	For Basic platform configuration, recommended minimum clock divider frequency is 100MHz clock divider maximum = 0xC00 For platform that support Wimax friendly clocking or overclocking, the recommended minimum clock divider frequency is 99.5463 MHz (clock divider maximum = 0xC0E). <ul style="list-style-type: none"> For more information on PCH SKU that support Wimax Friendly Clocking or overclocking, see appendix B.3.22
	SSC Change Allowed Mask	true		This determines if the SSC parameters of this clock resource can be controlled by the handled request record.
	SSC Spread Mode Control Up	false		
	SSC Spread Mode Control Center	false		
	SSC Spread Mode Control Down	true		
	SSC Spread Percent Max	50		
	Clock Usage	0x000	0x0D8	Change to indicate PCH PCI Express* and PCI (0x0D8) if overclocking is being utilized. Default is 0x000 .
	Section		Settings for Any Platform	
	120 MHz SSSC Graphics Clock (DIV4)		Treat as reserved.	

2.7 Build SPI Flash Binary Image

2.7.1 Build SPI Flash Binary Image

In the main menu select **Build | Build Image**. The image will be saved in the directory specified by **\$DestDir** parameter and will be named **outimage.bin**, unless the default **Output Directory** in **Build | Build Settings** was changed (see [Section 2.1](#)).

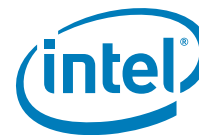
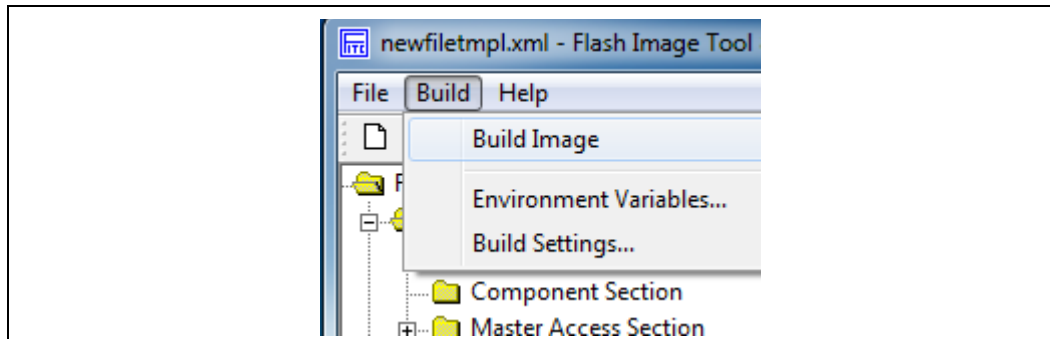

Figure 2-6. Build | Build Image



2.7.2 Save Your Settings

In the main menu select **File | Save As....** Select a name and location for the XML file that contains all the settings configured thus far. It is recommended that you save this file in your **[root]\Tools\System Tools\Flash Image Tool** directory for easy access.

Assuming that the custom settings file was saved as **customfile.xml** to the FITC directory (**[root]\Tools\System Tools\Flash Image Tool**), then these settings could be loaded in the FITC GUI itself using the main menu option **File | Load....**

Note: Previous platform (ie. Ibex Peak) generations of the FITC tool required multiple configuration files to be edited and saved. For this generation, only one configuration file (**customfile.xml**) is required.

This custom settings file could also be used to generate an SPI Flash binary image using the command line, with a command of the form:

```
fitc.exe [xml_file] [/o <file>] /b
```

Example usage: > fitc.exe newfiletmp.xml /o .\temp.bin /b

where:

- **<xml_file>** — The XML configuration file saved when configuring FITC.
- **/o <file>** — The path and filename where the image will be saved. This command overrides the 'Output path' in the XML file.
- **/b** — Automatically builds the Flash image. The FIT GUI will not be displayed when this flag is set, since FIT will run in auto-build mode. Error messages will be displayed by FITC, if necessary.

2.7.3 Protect Saved Configuration XML File

To avoid custom-configured values from ever overwritten when loading new binaries files (ie: when loading binaries into BIOS, GbE and ME regions in FITC) do the following (see [Figure 2-7](#)):

- After building the SPI Flash binary image and saving your configuration, close Flash Image Tool



- Right-click on the saved FITC configuration XML file (**customfile.xml**) and select **Properties**
- Check the **Read-Only** checkbox and click **OK**

Figure 2-7. Protecting FITC Configuration XML File

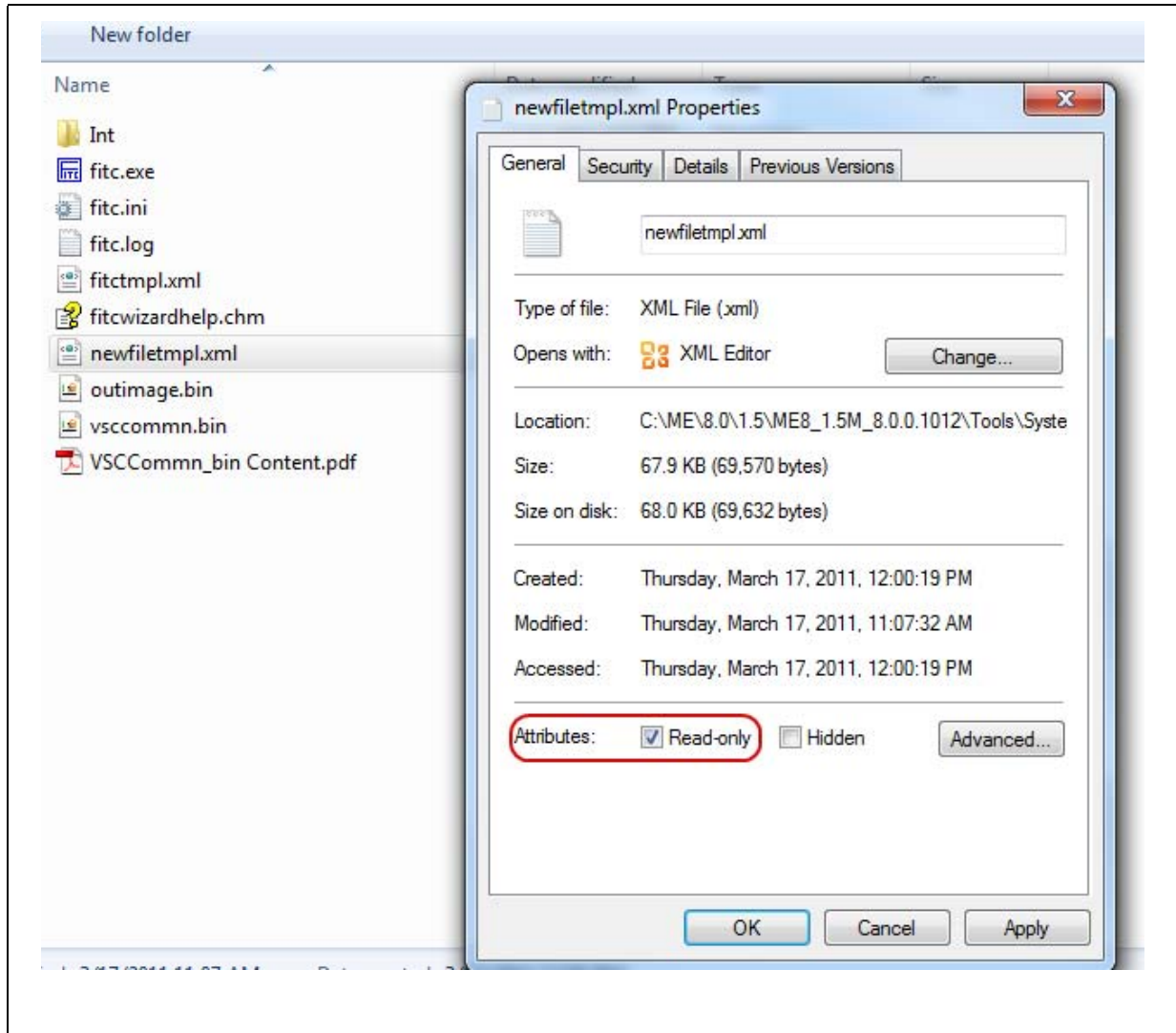

§ §



3 Image Creation: Flash Image Tool Wizard

Flash Image Tool (FITC) can be used to generate either a full SPI Flash binary image with Descriptor, GbE, BIOS, and Intel® ME Regions. Additionally, it can be used to create a simple image containing only the Intel® ME Region only for use with custom SPI Flash binary image assembly solutions. Use the steps shown in following sections.

After this image has been created, it will need to be burned onto the target platform's SPI Flash device(s). [Section 4, "Programming SPI Flash Devices and Checking Firmware Status"](#) later in this document provides steps to do this.

There are two different interfaces for this tool. A wizard mode and an advanced mode:

- For the wizard mode "FITC Wizard", please continue with this section. FITC Wizard is intended to streamline the Flash image creation process and is designed for ease of use. Most users should use this mode.
- For the advanced mode "FITC", please see [Section 2](#).

Note: The Flash Image Tool may be updated throughout the release cycles. As a general rule, please ensure you use the tools, images and other content from the same kit and refrain from using different version tools.

3.1 Start FITC and Load the Default Settings XML File

1. Invoke Flash Image Tool. Using Explorer*, navigate to **[root]\Tools\System Tools\Flash Image Tool**. Verify that the directory contents are correct (see [Section 1.7](#)). Double-click **fitc.exe**.
2. In the main menu select **File | Open...**. In the Open dialog that appears navigate to **[root]\Tools\System Tools\Flash Image Tool**. Click on **newfiletmp.xml** and click **OK**.

3.2 Step-by-Step Guide to Build SPI Flash Image with FITC Wizard Interface

Start the wizard mode by either pressing the **F9 key** or by using the menu option **Help | Wizard**. Next follow the steps in this section to create a 1.5MB5MB SPI Flash image.

Note: For platform intended to support WiMAX friendly clocking, set **SSC2PARMS = 0x1270_F418** and **SSC2OCPARMS = 0x0000_0300**. The SSC2PARMS and SSC2OCPARMS can only be accessed by using FITC advance mode. These registers can be found under ME Region | Configuration Data | ICC Profile X | ICC Registers.

For more information on PCH SKU that support WiMAX friendly clocking, see Appendix B.3.22.



Table 3-1. FITC Wizard - Serial Flash Configuration (Sheet 1 of 2)

#	CRB Setting	Settings for All Platforms
1	2	Set this to match the Number of Serial Flash devices on target platform
2 3	8MB for both SPI Flash devices	Set size to match Serial Flash devices on the platform. Note: Please consult with the platform hardware design to determine the appropriate setting.
4	Reports the total Serial Flash component size, updated in realtime	



Table 3-1. FITC Wizard - Serial Flash Configuration (Sheet 2 of 2)

#	CRB Setting	Settings for All Platforms
5	33MHz	Set to the lowest common frequency of all SPI Flash devices on the platform. Sets the following: <ul style="list-style-type: none"> • Read ID and Read Status clock frequency • Write and erase clock frequency • Fast read clock frequency
6	Unchecked	This setting determines if all SPI flash attached to the PCH will support the Single Input Dual Output Fast Read using Opcode 3Bh.
7	Set "Opcodes 0-3" to 0	The opcode specified here will not be permitted by the PCH's SPI controller for hardware sequencing. See Intel® <i>7 Series Chipset SPI programming Guide</i> for more details. 0 = no instruction is specified
8	FITC Wizard Jump Menu	Click the drop-down menu button to jump to another screen in the FITC Wizard. Accessible jump screens are highlighted in a bold font. Grayed out selections become bold and selectable during progression through the wizard. This allows for easy return to previous screens to change parameters.
9	Click the "Help" button on any page to get more information on the parameters and settings.	
Click Next to advance to the next screen.		



Table 3-2. FITC Wizard - Image Source Files (Sheet 1 of 2)

#	CRB Setting	Settings for All Platforms



Table 3-2. FITC Wizard - Image Source Files (Sheet 2 of 2)

#	CRB Setting	Settings for All Platforms
<p>1</p>	<p>Click Browse and select the ME FW image located in folder [root]\Image Components\ME \</p>	
<p>2</p>	<p>BIOS Image box checked and click Browse to select desktop/mobile CRB BIOS Image located in the kit at: [root]\Image Components\BIOS\</p>	<p>Check the BIOS Image box if BIOS is stored in the same SPI Flash as ME FW Image and Integrated LAN Image. Next click Browse and choose your BIOS image.</p> <p><input checked="" type="checkbox"/> BIOS Image</p> <p>If the BIOS image is stored in a separate SPI Flash device (see Configurations "B", "C", and "D" in Appendix A) then uncheck BIOS Image box.</p>
<p>3</p>	<p>Intel® Integrated LAN Image box checked and click Browse to select CRB LAN Image located in the kit at: [root]\Image Components\GbE\</p>	<p><input checked="" type="checkbox"/> Intel Integrated LAN Image</p> <p>Check the Intel® Integrated LAN Image box if using Intel® LAN. Next click Browse and choose CRB LAN Image located in the kit at: [root]\Image Components\GbE\</p> <p>If not using Intel® LAN then uncheck Intel® Integrated LAN Image box.</p>
<p>4</p>	<p>By default PDR Image box is unchecked. Select this box if a Platform Data Region (PDR) is needed for your platform.</p>	
<p>5</p>	<p>Reports the total Flash component size, updated in real-time</p>	
<p>Click Next to advance to the next screen, or Back to return to the previous screen.</p>		



Table 3-3. FITC Wizard - VSCC Configuration

#	CRB Setting	Settings for All Platforms
<p>1</p>	<p>Intel® CRBs use Flash devices W25Q64BV or AT26DF321. If the Flash device used on your platform is listed here, then click Next at the bottom of the screen to proceed. Otherwise, continue onto Step 2 to add your Flash device information.</p>	
<p>2</p>	<p>Entry Name: W25Q64BV Vendor ID: 0xEF Device ID 0: 0x40 Device ID 1: 0x17 ME VSCC Value: 0x20052005</p>	<p>Using your SPI Flash device datasheet and <i>Intel® 7 Series/C216 Chipset Family SPI Flash Programming Guide</i>, enter the values for each field.</p>
<p>3</p>	<p>Click Add Entry button to add this Flash device to the list.</p>	
<p>4</p>	<p>Flash device information can be updated by first selecting the Flash device from the list and then clicking the Edit Entry button.</p>	
<p>Click Next to advance to the next screen, or Back to return to the previous screen.</p>		

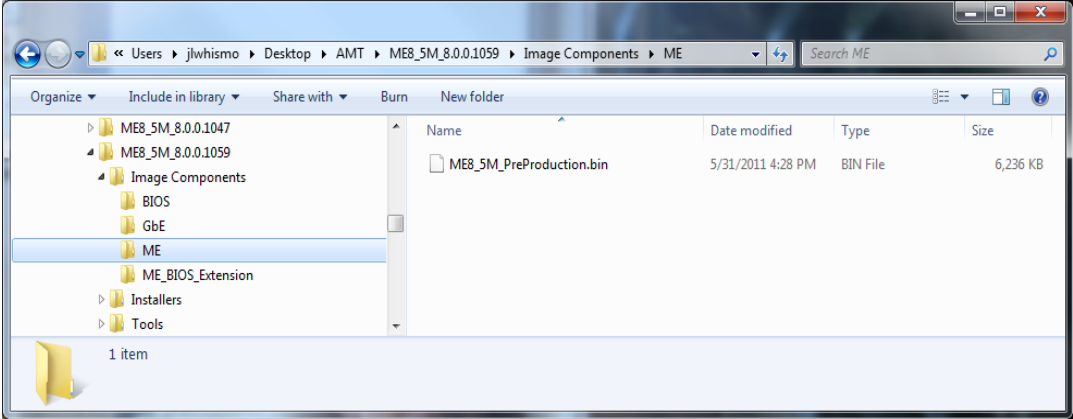
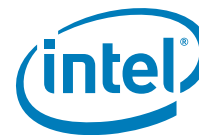

Table 3-4. FITC Wizard - LAN Configuration (Sheet 1 of 2)

#	CRB Setting	Settings for All Platforms
<p>1 2</p>	<p>Checked and select 101: Port 6</p>	<p>Checked = Intel® LAN is present. Select PCH PCI Express* port utilized for GbE LAN PHY. Unchecked = Third-party LAN is present. The port selection parameter will be grayed out. <i>Note:</i> Please consult with the platform hardware design to determine the appropriate setting.</p>
<p>3</p>	<p>Checked</p>	<p>Checked = Only required if the target platform has an Intel® Integrated LAN and PCH GPIO12 is used as LANPHYPC for Intel® LAN PHY Power Control signal. Unchecked = PCH GPIO12 is used as General Purpose Input/Output (GPIO) pin. This setting must be Unchecked if Third-party LAN is present. <i>Note:</i> Please consult with the platform hardware design to determine the appropriate setting.</p>



Table 3-4. FITC Wizard - LAN Configuration (Sheet 2 of 2)

#	CRB Setting	Settings for All Platforms
<div style="background-color: red; color: white; border-radius: 50%; width: 30px; height: 30px; display: flex; align-items: center; justify-content: center; margin: 0 auto;">4</div>	<p>Unchecked</p>	<p>This setting should be unchecked to enable MACsec.</p> <p>The “MACsec ready” bit in the ME descriptor region should be enabled for support.</p> <ul style="list-style-type: none"> • This bit must be set in the manufacturing plant and will not be accessible after shipment. <p>MACsec is a hop-by-hop network security solution. It provides Layer 2 encryption and authenticity/integrity protection for packets traveling between MACsec-enabled nodes of the network. The key components that need to support this functionality are the server, client and switch network interface devices.</p> <p>Note: If MACsec is enabled by IT in the network infrastructure Intel® AMT will not function properly. See IBL document 461067 for further details.” CDI is an Intel®-internal term. IBL is what the customers use.</p>
<p>Click Next to advance to the next screen, or Back to return to the previous screen.</p>		



Table 3-5. FITC Wizard - Intel® ME Application Permanent Disable (Sheet 1 of 2)

#	CRB Setting	Settings for All Platforms
<p>1</p>		<p>Select the Platform Type that you wish to emulate on pre-production silicon. Valid Choices are:</p> <ul style="list-style-type: none"> • Intel® 7 Series Chipset • Intel® 6 Series Chipset
<p>2</p>	<p>Select the Platform Type/SKU type that you wish to emulate on pre-production silicon. Valid Choices for Intel® 7 Series Chipset Platform are:</p>	<ul style="list-style-type: none"> • Intel® Z77 Express Chipset • Intel® Z75 Express Chipset • Intel® H77 Express Chipset • Intel® H71 Express Chipset • Mobile Intel® HM70Express Chipset • Mobile Intel® HM76 Express Chipset • Mobile Intel® HM75 Express Chipset • Mobile Intel® UM77 Express Chipset • Mobile Intel® QS77 Express Chipset • Mobile Intel® HM77 Express Chipset



Table 3-5. FITC Wizard - Intel® ME Application Permanent Disable (Sheet 2 of 2)

#	CRB Setting	Settings for All Platforms
2	Select the Platform Type SKU from the drop-down on pre-production silicon. Valid Choices for Intel® 6 Series Chipset Platform are:	<ul style="list-style-type: none"> • Intel® H67 Express Chipset • Intel® P67 Express Chipset • Intel® H61 Express Chipset • Intel® Z68 Express Chipset • Mobile Intel® HM65 Express Chipset
3	Grayed out	<p>The Manageability Application feature is not supported on 1.5MB FW SKUs and is grayed out</p> <p>The 'KVM Permanently Disable' checkbox will disable the KVM system when selected.</p>
4	Unchecked	Intel® ME Network Services. If Permanently Disable is checked this will disable all ME Network Services communication except ARP offload and RMCP ping response.
5	Unchecked	If using Intel® integrated graphics solution and the target platform supports HD playback support from the Intel® Graphics driver, then PAVP must NOT be Disabled. Availability of PAVP feature is dependent on the SKU Type selected in Step 1. If this feature is not grayed out, then you have the option to permanently disable it by checking this box.
6	Unchecked	<p>Checked = disables the Intel® Anti-Theft Technology (Intel® AT) feature.</p> <p>Unchecked = enables the Intel® Anti-Theft Technology (Intel® AT) feature.</p> <p>Note: Availability of Intel® AT feature is dependent on the SKU type selected in Step 2.</p>
Click Next to advance to the next screen, or Back to return to the previous screen.		



Table 3-6. FITC Wizard - Intel® ME Kernel Configuration Parameters (Sheet 1 of 2)

#	CRB Setting	Settings for All Platforms
1	No Emulation	Set this parameter to the type of processor that the target system will use during production. This field will emulate that processor class for pre-production silicon. It is necessary to set this to 'EMULATE Intel® vPro (TM) capable Processor' in order to enable Intel® AMT feature support on pre-production CPUs
2	No onboard glue logic	This value will determine if glue logic is present on a Desktop platform to detect a missing processor. Choices are: <ul style="list-style-type: none"> No onboard glue logic Glue logic tied to GPIO24 Note: Please consult with the platform hardware design to determine the appropriate setting.
3	Checked	This option is to allow host access to the ME region during manufacturing/debug environments. See HMRFP0 Intel® MEI Message Support in <i>Intel® 7 Series/C216 Chipset Family ME BIOS Writers Guide</i> for more details. Note: This setting is dependent on BIOS implementation. Please consult with the target platform's BIOS vendor to determine the appropriate setting.
4	Unchecked	This enables Intel®ME M3 auto test during platform early boot.



Table 3-6. FITC Wizard - Intel® ME Kernel Configuration Parameters (Sheet 2 of 2)

#	CRB Setting	Settings for All Platforms
5	Grayed out	Intel® Intel® Please consult with the platform hardware design to determine the appropriate setting Power Package 2: not supported for 1.5MB SKU
6	Checked	This value will determine if M3 power rail is present on the platform for proper firmware behavior Checked = Platform hardware supports M3 power rail Unchecked = Platform hardware has no separate M3 power rail Note: Please consult with the platform hardware design to determine the appropriate setting. Note: This value is automatically checked and greyed out if Power Package 2 Supported is checked.
7	Unchecked	Checked = Platform HW configuration supports DSW rail and entry into Deep Sx. Unchecked = For mobile platforms, platform EC supports SUSPWRDNACK capability. For desktop platforms, platform does not support DSW rail or Deep Sx. Note: Please consult with the platform hardware design to determine the appropriate setting.
8	SLP_LAN# (MGPIO3)	This informs the Intel® ME how the Intel® LAN well is powered. If the target platform is NOT using Intel® LAN then set this to Core Well . Choices for LAN Power Well Config are: <ul style="list-style-type: none"> • Core Well • Sus Well • ME Well • SLP_LAN# Note: Please consult with the platform hardware design to determine the appropriate setting.
9	Disabled	This informs Intel® ME how the Intel® WLAN is powered. If the target platform is NOT using WLAN for Manageability (Intel® AMT) then set this to Disabled . Choices for WLAN Power Well Config are: <ul style="list-style-type: none"> • Disabled (Default) • Sus Well • ME Well • Controlled via SLP_M# SLP_ME_CSW_DEV# Note: Please consult with the platform hardware design to determine the appropriate setting.
10	FW Update OEM ID 00000000-0000-0000-0000-0000-000000000000	FW Update OEM ID This field provides the ability to target FWUpdate (FWUpdLcl.exe) by Platform OEM. This ID will make sure that customers can only update a platform with an image coming from the platform OEM. If set to all zeros, then any input is valid when doing a firmware update.
Click Next to advance to the next screen, or Back to return to the previous screen.		



Table 3-7.

#	CRB Setting	Settings for All Platforms
<p>1</p>	<p>Default</p>	<p>Configures the Manageability Engine Redirection ports: Default - Enables all ports with no User Consent required for Redirection . (Security Level Low) Enhanced - Requires User Consent for Redirection . (Security Level Medium) Extreme - Disables Redirection (Security Level High)</p>
<p>2</p>	<p>Checked</p>	<p>Checked = Enables KVM to use keyboard and mouse input on USB ports connected to EHCI 1 Unchecked = Disables KVM to use keyboard and mouse input on USB ports connected to EHCI 1</p>
<p>3</p>	<p>Unchecked</p>	<p>Checked = Enables KVM to use keyboard and mouse input on USB ports connected to EHCI 2 Unchecked = Disables KVM to use keyboard and mouse input on USB ports connected to EHCI 2</p>
<p>Click Next to advance to the next screen, or Back to return to the previous screen.</p>		



Table 3-8. FITC Wizard - Intel® ME Networking Services Setup

#	CRB Setting	Settings for All Platforms
<p>1</p>	<p>ODM ID: 0x00000000 Reserved ID: 0x00000000 System Integrator ID: 0x00000000 Sub System Vendor ID 0x0000</p>	<p>These fields are used by Intel® Services. Intel® Identity Protection Technology (Intel® IPT) use ODM ID field only (for platform identification between the OEM and the ISBV).</p>
<p>2</p>	<p>Greyed out</p>	<p>Treat as reserved</p>
<p>Click Next to advance to the next screen, or Back to return to the previous screen.</p>		

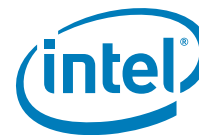

Note: The following screen on Intel® Anti Theft Technology Setup can only be accessed if the box for “Permanently Disable Intel® Anti Theft Technology?” (see Table 3-5) is unchecked. Otherwise, continue with the next FITC Wizard screen on the next page.

Table 3-9. FITC Wizard - Intel® Anti Theft Technology Setup (Sheet 1 of 2)

#	CRB Setting	Settings for All Platforms
<p>1</p>	<p>Unchecked</p>	<p>Checked = The Unsigned Assert Stolen is enabled Unchecked = The Unsigned Assert Stolen is disabled</p>
<p>2</p>	<p>Unchecked</p>	<p>This timer will enable a 30 minute window to allow a firmware / BIOS re-flash before the system is powered down</p> <p>Note: This setting is dependent on BIOS implementation. Please consult with the platform's BIOS vendor to determine the appropriate setting.</p>



Table 3-9. FITC Wizard - Intel® Anti Theft Technology Setup (Sheet 2 of 2)

#	CRB Setting	Settings for All Platforms
3	<p>Allowed When AT Not Provisioned</p>	<p>This option determines if the Intel® ME will enter a disabled state to allow full SPI device re-flashing when the manufacturing override jumper (HMFPRO) is set.</p> <p>Always Allowed - Full SPI re-flash will always be allowed regardless of AT enrollment state.</p> <p>Allowed When AT Not Provisioned - Full SPI re-flash allowed if AT has not been enrolled.</p>
4	<p>Allowed When AT Not Provisioned</p>	<p>This option determines if the Intel® ME will enter a disabled state via BIOS based MEI messages and allow Intel® ME only region re-flash.</p> <p>Always Allowed - Intel® ME region re-flash will always be allowed regardless of AT enrollment state.</p> <p>Allowed When AT Not Provisioned - Intel® ME region re-flash allowed if AT has not been enrolled.</p>
5	<p>Address Enable unchecked</p> <p>Address 0x2B</p>	<p>This setting is for 3G NIC support for Intel® AT. If this card is supported by the target platform, then select Address enable and set the SMBus address for the card.</p> <p>Note: Please consult with the platform hardware design to determine the appropriate setting.</p>

Click **Next** to advance to the next screen, or **Back** to return to the previous screen.



Table 3-10. FITC Wizard - DMI/PCIe* Configuration

#	CRB Setting	Settings for All Platforms
1	Unchecked	<p>DMI and FDI Lanes Reversed option must reflect platform topology. See <i>Intel® 7 Series/C216 Chipset Family SPI Flash Programming Guide</i> for more details.</p> <p>Note: Please consult with the platform hardware design to determine the appropriate setting.</p> <p>When using Small Form Factor CRB platforms (SKU QS77 and UM77), Set this value to 'true'.</p>
2	4x1	<p>PCIe* Lanes 1-4 Configuration panel must reflect platform topology. Note: PCIe* lane 1 reversed option is available only when 1x4 - one four lane PCIe* port is selected.</p> <p>Please consult with the platform hardware design to determine the appropriate setting.</p>
3	4x1	<p>PCIe* Lanes 5-8 Configuration panel must reflect platform topology. Note: PCIe* lane 5 reversed option is available only when 1x4 - one four lane PCIe* port is selected.</p> <p>Note: Please consult with the platform hardware design to determine the appropriate setting.</p>
Click Next to advance to the next screen, or Back to return to the previous screen.		



Table 3-11. FITC Wizard - Thermal Reporting (Sheet 1 of 2)

#	CRB Setting	Settings for All Platforms
1	Checked for CRB	<p>Checked = Check this for EC/SIO/BMC to interact Thermal Reporting feature over SMLink1 Unchecked = Platform has no EC/SIO/BMC on SMLink1</p> <p>Note: Please consult with the target hardware designer to determine this setting.</p>
2	CRB uses 0x4C	<p>Denotes EC/SIO/BMC SMBus write address over SMLink1.</p> <p>For mobile platforms, this field cannot be blank, otherwise the Next button will be disabled.</p> <p>Note: Please consult with the platform hardware design to determine the appropriate setting.</p>
3	CRB uses 0x4B	<p>Denotes EC/SIO/BMC SMBus read address over SMLink1.</p> <p>For mobile platforms, this field cannot be blank, otherwise the Next button will be disabled.</p> <p>Note: Please consult with the target hardware designer to determine this setting.</p>

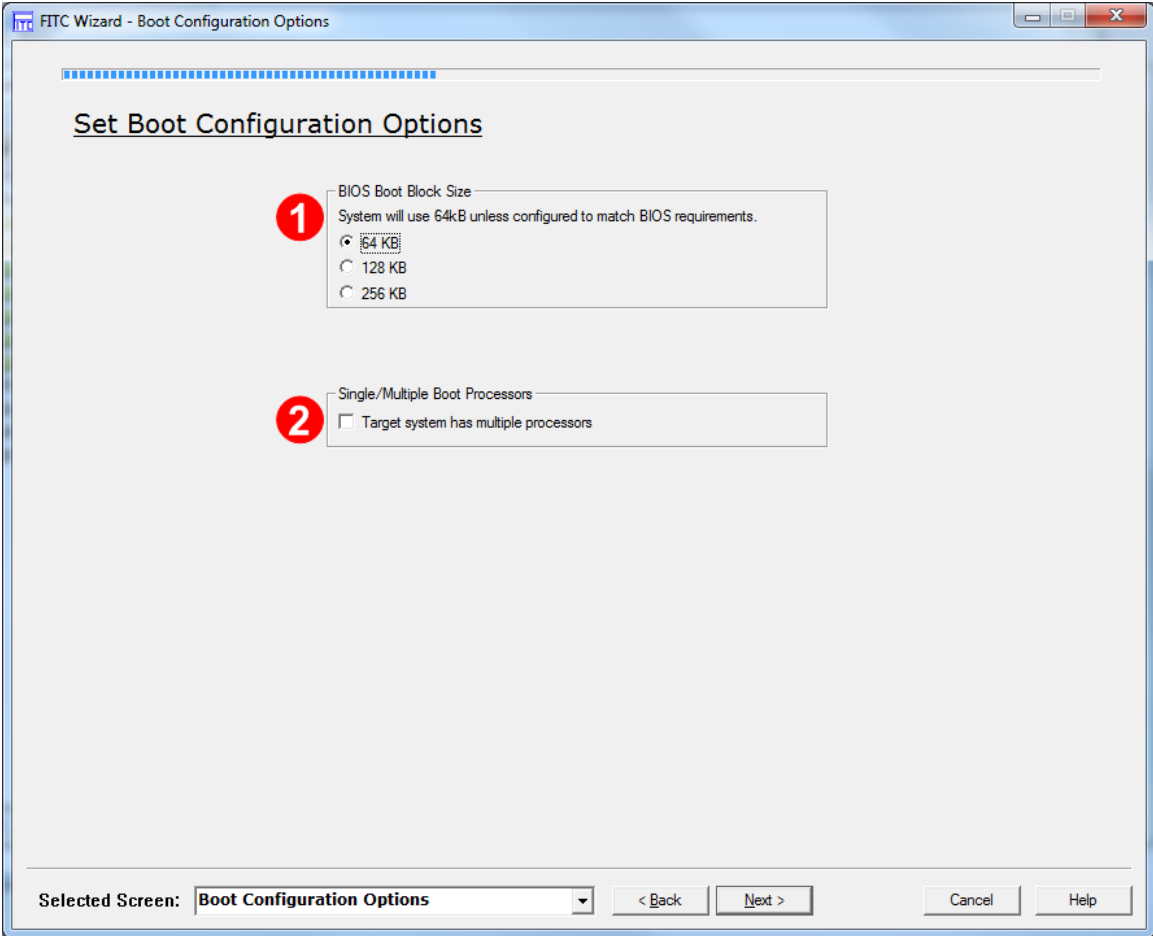

Table 3-11. FITC Wizard - Thermal Reporting (Sheet 2 of 2)

#	CRB Setting	Settings for All Platforms
<div style="background-color: red; color: white; border-radius: 50%; width: 30px; height: 30px; display: flex; align-items: center; justify-content: center; margin: 0 auto;">4</div>	<p>Desktop - CPU, PCH, & DIMMS</p> <p>Mobile - PCH Only</p>	<p>Select between thermal reporting using:</p> <ul style="list-style-type: none"> • CPU, PCH, & DIMMS: Legacy Intel®ME FW SMBus based thermal reporting that reports Processor, PCH and DIMMS <p>Note: ME Thermal Reporting: Advantage = Does not require PECI capability in EC. Disadvantage = no real time temperature alert level control, and no dynamic Sandy Bridge or Ivy Bridge CPU Turbo controls.</p> <ul style="list-style-type: none"> — PECI from Sandy Bridge processor is connected to PCH — BIOS sets Thermal Reporting Control (TRC) MMIO register at TBARB+1Ah to enable ME reporting of processor, PCH, and DIMM temperatures (as appropriate) — Intel®ME thermal reporting PCI device should be enabled for proper interaction with EC, SIO, BMC, or equivalent fan control logic <ul style="list-style-type: none"> • PCH Only: HW based PCH only thermal reporting. This would require PECI to be hooked up directly to EC/SIO in order to get processor temperature <p>Note: Platform based Thermal Reporting: Advantage = allows full dynamic Sandy Bridge / Ivy Bridge Turbo control. Disadvantage = Requires EC/BMC with PECI capability.</p> <ul style="list-style-type: none"> — PECI from Sandy Bridge processor is connected direct to EC, SIO, BMC, or equivalent fan control logic — BIOS sets Thermal Reporting Control (TRC) MMIO register at TBARB+1Ah = 0x0, disabling Intel®ME reporting of processor, PCH, and DIMM temperatures — Intel®ME thermal reporting PCI device should be disabled
Click Next to advance to the next screen, or Back to return to the previous screen.		



Table 3-12. FITC Wizard - Boot Configuration Options (Sheet 1 of 2)

#	CRB Setting	Settings for All Platforms
		
<p>1</p>	<p>64 KB</p>	<p>BIOS Boot Block Size is the bare minimum BIOS code required to boot a platform. This setting allows for proper address bit to be inverted as required by BIOS Boot Block Size.</p> <p>64KB = Invert A16 if Top Swap is enabled 128KB = Invert A17 if Top Swap is enabled 256KB = Invert A18 if Top Swap is enabled</p> <p>If BIOS is stored in a separate SPI Flash device (see Appendix A for details about Configurations "B", "C", and "D") then leave this parameter at 64KB.</p> <p>Note: This field will be disabled when BIOS Image (see Table 3-2) is not checked.</p> <p>Note: This must be determined by the target platform BIOS developer.</p>

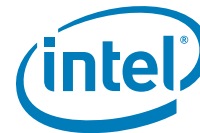

Table 3-12. FITC Wizard - Boot Configuration Options (Sheet 2 of 2)

#	CRB Setting	Settings for All Platforms
2	Unchecked	<p>Indicates if RequesterID checking during DMI accesses is disabled. This parameter is only applicable for server platforms that contain multiple Processors.</p> <p>Unchecked = single Processor in the same platform</p> <p>Checked = multiple Processors in the same platform</p> <p>Note: Please consult with the platform hardware design to determine the appropriate setting.</p>
Click Next to advance to the next screen, or Back to return to the previous screen.		



Table 3-13. FITC Wizard - Integrated Clock Configuration

#	CRB Setting	Settings for All Platforms
#	CRB Setting	Settings for All Platforms
1	1	<p>SPI flash binary images across multiple board designs can contain the same block of Clock Control Parameters (OEM Request Records), up to 7 sets total. This parameter selects how many total OEM Request Records will be built into the image.</p> <p>Note: The next 2 screens will be repeated for as many OEM Request Records that will be present.</p>
2	Soft Strap	<p>If more than one OEM Request Record is present in SPI, then this parameter specifies whether Soft Strap or BIOS determines the ICC Boot Profile. Note that the BIOS option has additional BIOS requirements, see <i>BIOS Writers Guide</i> for more details. These requirements include:</p> <ul style="list-style-type: none"> • Details on the Intel® MEI message BIOS can use to read or specify ICC Boot Profile • Details on reset requirements after BIOS has specified an ICC Boot Profile
3	0	<p>Specifies which clock control parameter set is to be used by the final generated SPI flash binary image by the target platform at boot time. This parameter is only used if ICC Boot Profile is specified by Soft Strap. If BIOS is specifying ICC Boot Profile, then this parameter is unused.</p>
Click Next to advance to the next screen, or Back to return to the previous screen.		

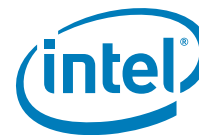

Table 3-14. FITC Wizard - ICC Profile 0 Single-Ended Clocks (Sheet 1 of 2)

#	CRB Setting	Settings for All Platforms
<p>1</p>	<p>Checked for all PCI and FLEX clocks</p>	<p>Unchecked = Output clock is gated to low state Checked = Output buffer is enabled to toggle once its clock source has been initialized</p>
<p>2</p>	<p>33.3 MHz for FLEX0, FLEX2 14.31818 MHz for FLEX1 24/48MHz for FLEX3</p>	<p>Controls muxing to select sources for FLEX clock outputs. Note: PCI clock outputs are fixed at 33 MHz, but FLEX clock outputs may be configured to act as PCI outputs. Note: These clock select settings only take effect when this muxed FLEXCLK/GPIO pin is configured for FLEXCLK native usage. Refer to the Panther Peak EDS for configuration of GPIO vs. native usage. Note: 27 Mhz option is available in the tool, but is not extensively tested by Intel® and is not recommended for use.</p>
<p>3</p>	<p>4-Default Slew Rate for all PCI and Flex clocks</p>	<p>Controls slew rate for PCI and FLEX clocks. PCI Specifications 2.4 and 3.0 allow for an acceptable slew rate range of 1 to 4 V/ns. ME FW programmability allows for slew rate to be specified between 0.6 to 2 V/ns for two reasons:</p> <ul style="list-style-type: none"> • Slew rates exceeding 2 V/ns can have adverse effects on platform EMI • Slew rates lower than 1 V/ns can be specified for EMI benefits, at the risk of violating PCI specification



Table 3-14. FITC Wizard - ICC Profile 0 Single-Ended Clocks (Sheet 2 of 2)

#	CRB Setting	Settings for All Platforms
4	Double-loaded for all PCI and FLEX clocks	Sets programmable series resistance for PCI and FLEX clocks.
5	Unchecked for all PCI and FLEX clocks	Enables support for CLKRUN protocol for PCI 33 MHz clocks muxed out to CLKOUTFLEX[3:0] and CLKOUT_PCI[4:0]. Unchecked = Corresponding CLKOUTFLEX PCI clock is free-running, unaffected by CLKRUN protocol Checked = Corresponding CLKOUTFLEX PCI clock is shut off when CLKRUN protocol turns off PCI clocks Note: When the corresponding CLKOUTFLEX pins are not configured for PCI 33Mhz clock, this option is disabled and unchecked .
6	Reports the dword values of FCSS, OCKEN, SEBP1, SEBP2, and PM2 Clock Control Parameters, as they are affected by the settings on this screen. See Appendix B for more information on Clock Control Parameters.	
Click Next to advance to the next screen, or Back to return to the previous screen.		



Table 3-15. FITC Wizard - ICC Profile 0 Platform & Differential Clocks (Sheet 1 of 2)

#	CRB Setting	Settings for All Platforms
<p>1</p>	<p>Checked for all differential clock outputs (PEG[B:A], SRCITPXD P, SRC[7:0], DP120)</p>	<p>Unchecked = Output clock is gated to low state Checked = Output buffer is enabled to toggle once its clock source has been initialized</p>
<p>2</p>	<p>Disable dynamic control for all PCI Express* clocks (PEG[B:A], SRCITPXD P, SRC[7:0])</p>	<p>Assigns dynamic CLKRQ# control of SRC clocks. Each PCI Express* clock may be assigned to a muxed CLKRQ#/GPIO PCH pin. Note: These CLKRQ# settings only take effect when this muxed CLKRQ#/GPIO pin is configured for CLKRQ# native usage. Refer to the <i>Intel® 7 Series/C216 Chipset Family EDS</i> for configuration of GPIO vs. native usage.</p>
<p>3</p>	<p>Full Clock Integration Mode - NO Overclocking</p>	<p>Full Clock Integration Mode - NO Overclocking = PCH natively generates all platform clocks. Platform will not utilize BCLK overclocking. Full Clock Integration Mode - YES Overclocking = PCH natively generates all platform clocks. Platform <u>WILL</u> utilize BCLK overclocking. Display Clock Integration= This is NOT an ICC mode that is supported by the Intel® 7 Series/C216 Chipset Family. This mode will not be validated by Intel® and should not be used in Intel® 7 Series/C216 Chipset Family.</p>



Table 3-15. FITC Wizard - ICC Profile 0 Platform & Differential Clocks (Sheet 2 of 2)

#	CRB Setting	Settings for All Platforms
<p style="text-align: center;">4</p>	<p style="text-align: center;">Integrated Only or Integrated & 27MHz Discrete Graphics Down Device</p>	<p>External Graphics only = Use this setting if platform supports external graphics only</p> <p>Integrated Only or Integrated & 27MHz Discrete Graphics Down Device = Display clock will be controlled by Intel® Integrated Graphics Device Driver and the Display Clock will only be supplied to the Intel® Integrated Graphics Device. Any Graphics Down Devices with 27-MHz clock requirement is required to utilize an external 27-MHz crystal since:</p> <ul style="list-style-type: none"> • PCH cannot simultaneously supply 120 MHz Integrated Graphics clock and 27-MHz Down Device clock simultaneously • Simultaneous clocking is required for both switchable and mixed graphics configurations <p>Discrete Graphics Down Device Only = This option is NOT supported in Intel® 7 Series/C216 Chipset Family</p> <p>External Graphics only = Use this setting if platform supports external graphics only</p>
<p style="text-align: center;">5</p>	<p>Reports the dword values of OCKEN, CSS, PLLRCS, DIVEN, PMSRCCLK1, PMSRCCLK2, IBEN, SSS, SSCCTL, PI12BIASPARAMS, and PLEN Clock Control Parameters, as they are affected by the settings on this screen. See Appendix B for more information on Clock Control Parameters.</p>	
<p>Click Next to advance to the next screen, or Back to return to the previous screen.</p>		



Table 3-16. FITC Wizard - Production/Nonproduction Configuration (Sheet 1 of 2)

#	CRB Setting	Settings for All Platforms
<p>1</p>	<p>Non-production mode</p>	<p>Selecting Production Mode sets the following:</p> <ul style="list-style-type: none"> • BIOS Region Master Access Permissions set to 0x0B for read access and 0x0A for write access • Intel[®] ME FW Region Master Access Permissions set to 0x0D for read access and 0x0C for write access • GbE FW Region Master Access Permissions set to 0x08 for both read and write access • ME SMBus Diagnostic Console capability is disabled • MDDD capability is disabled <p>Selecting Non-production Mode sets the following:</p> <ul style="list-style-type: none"> • Master Access Permissions for all SPI Flash Regions set to 0xFF for both read and write access • Intel[®] ME SMBus Diagnostic Console capability is disabled • MDDD capability is disabled <p>Production Mode is for a system as it would be shipped. Non-production Mode is for debug and simplifies flashing new images onto SPI Flash.</p> <p>Production Mode With BIOS Read/Write Access to PDR - This option functions the same as Production Mode with the addition of allowing BIOS Read and Write access to the Platform Data Region for the SPI flash.</p>



Table 3-16. FITC Wizard - Production/Nonproduction Configuration (Sheet 2 of 2)

#	CRB Setting	Settings for All Platforms
2	Unchecked	For mobile platforms only. When this field is checked , Intel® Management Engine will assert CL_RST1# when it resets. When set to unchecked , Intel® ME does not reflect this reset.
3	Unchecked	Enabled Intel® ME Debug to operate in emergency mode. See Intel® ME Debug documentation for more detail.
4	Enabled: Unchecked Address: 0x00	Note: This option should not be enabled. Treat as Reserved.
Click Next to advance to the next screen, or Back to return to the previous screen.		



Table 3-17. FITC Wizard - Build (Sheet 1 of 2)

#	CRB Setting	Settings for All Platforms
		
1	Specify filename and directory location of output image. By default, the filename used is outimage.bin and the location will be in the same directory as fitc.exe .	



Table 3-17. FITC Wizard - Build (Sheet 2 of 2)

#	CRB Setting	Settings for All Platforms
2		<p>Click Build to create the SPI Flash image.</p> <p>Note: In addition to the outimage.bin file created, there may be two extra output images created as well,</p> <ul style="list-style-type: none"> • outimage(1).bin • outimage(2).bin <p>These two images are used for programming the SPI Flash devices separately (for example, using an external Flash programmer).</p> <p>Note - Full Clock Integration Mode - NO Overclocking: You may experience a test fail result for Intel® Management Engine Test Suite (Intel® ME Test Suite) test ICC_TST_10, unless you set an additional value in FITC after finishing with Wizard. This means you will not Build an image after finishing the Wizard. Instructions:</p> <ul style="list-style-type: none"> • In FITC (not Wizard mode) navigate to Flash Image ME Region Configuration ICC Data ICC Profile 0 Clock Range Definition Record 0 (or appropriate record #0-7) • Navigate to subfolder Clock Range Definition Record Processor or Platform DMICLK (DIV2-S). You will be changing a setting for the main PCI Express* clock divider • Change parameter Clock Div Min to 0xC00 • Change parameter Clock Div Max to 0xC00 for basic configuration. If platform support Wimax friendly clocking, set the value to 0xC0E <p>Not taking the above steps has <u>no</u> risk or issue for production configuration and is meant to help platform successfully meet METS requirements for ICC_TST_11 only.</p>
3		<p>Click Finish to preserve all Wizard build settings and parameters and return to FITC advanced mode.</p>
<p>Click Next to advance to the next screen, or Back to return to the previous screen.</p>		

After clicking **Build**, the Flash image will be created and all setting will be present in FITC. If you want to save the setting, use File -> Save as, to save the settings in the **xml** specified.

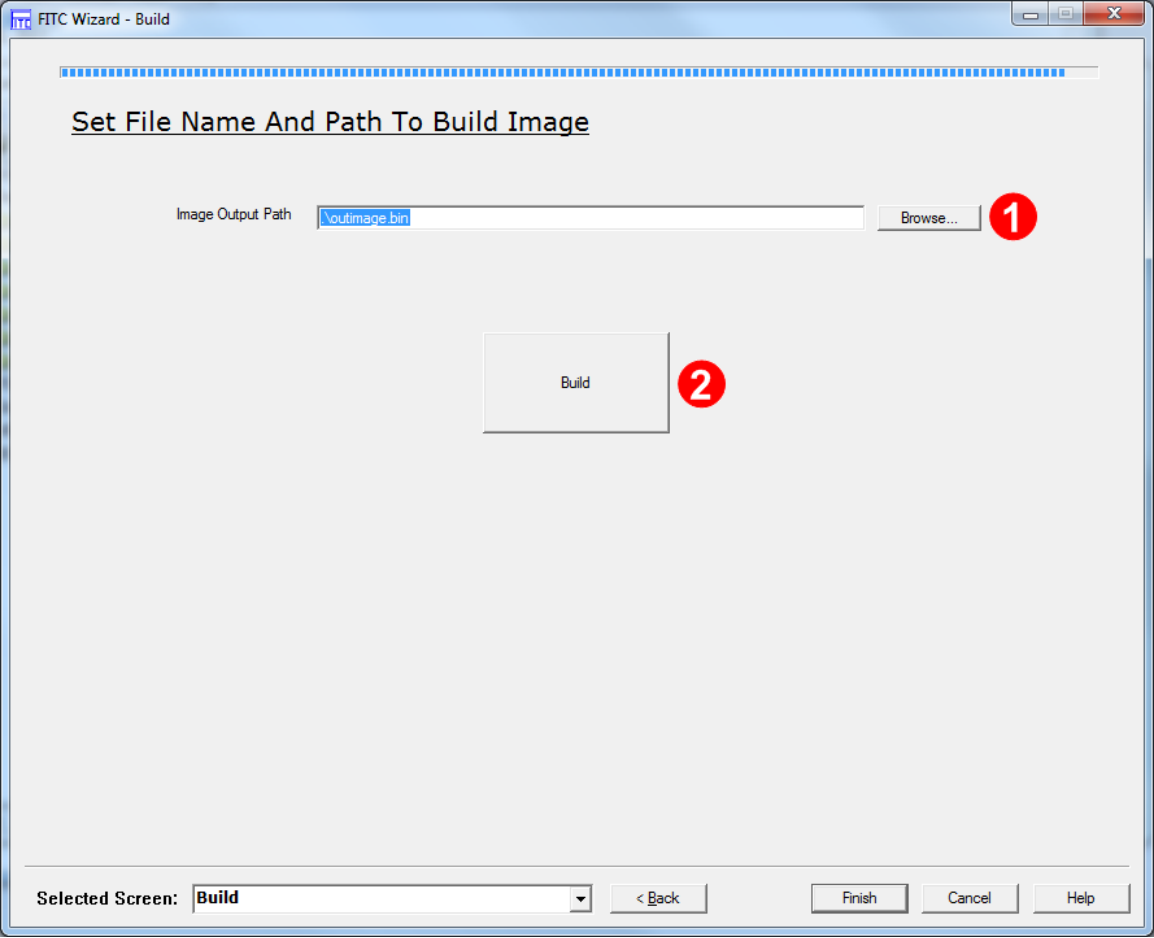
Now that the 1.5MB5MB SPI Flash image has been created, you may jump to [Section 4, "Programming SPI Flash Devices and Checking Firmware Status"](#).

Section 2, "Image Creation: Flash Image Tool (FITC)" is only intended

for advanced Flash image creation and most users will not need to follow it.

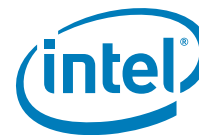

3 Programming SPI Flash Devices and Checking Firmware Status

Now that the Flash image file has been created, it can be programmed into the SPI Flash device(s) of the target machine. For platforms that don't boot, a Flash Chip Programmer will be required. For platforms that can boot to DOS or Windows*, the Flash Programming Tool (FPT) can be used.

3.1 Flash Burner/Programmer

The specific use of a Flash burner/programmer is beyond the scope of this document. However, the following general steps may be followed:

1. Navigate to your **Output Directory** (as specified in [Section 3.2](#) or [Section 2.6.2](#)) where your generated SPI Flash image(s) are saved. It is assumed that this image file is named **outimage.bin**.

If two total SPI Flash devices were specified during the build process, then additional image files will be saved, one for each SPI Flash device. These files are assumed to be named **outimage(1).bin** and **outimage(2).bin**.

2. Utilize a Flash burner/programmer to program the image(s). For multiple SPI Flash devices, the images are numbered sequentially to correspond to the first and second SPI Flash device accordingly.

3.1.1 In-Circuit SPI Flash Programming for Mobile CRB

Mobile CRBs have the SPI Flash devices soldered down. As a result, to program the SPI Flash for mobile CRBs, follow these steps:

1. Leave mobile CRB powered off.
2. Connect Flash Programmer (such as DediProg SF100) header to connector **J8E1** which is labelled "**SPI PROG**". Make sure to line up pin 1 on the header.
3. Change the jumpers to the "**Programming SPI-0**" mode as shown in [Table 4-1](#) below.

Table 3-1. Jumper Settings for Mobile CRB SPI Flash Programming

Mode	J8C4	J8C5	J8D1
Programming SPI-0	1-2	1-2	1-2
Programming SPI-1	1-2	1-2	2-3
Normal Operation	1-X	1-X	1-X

4. Program the first image [outimage(1).bin] to the CRB.
5. Following [Table 4-1](#), change the jumpers to the "**Programming SPI-1**" mode.
6. Program the second image [outimage(2).bin] to the CRB.
7. Once programming is complete, disconnect the Flash Programmer header. The CRB is now ready for power on.



3.2 Flash Programming Tool (FPT)

FPT can be used to substitute for a Flash burner/programmer, provided the system is capable of booting to a DOS or Windows OS.

Note: FPT will automatically disable the Intel® ME prior to flashing the image to the platform.

FPT DOS Version

The DOS versions supported by FPT are: DOS, Free DOS, and DRMK DOS. Use the following steps to program the SPI Flash devices,

1. Copy all the files in the “(root)\Tools\System Tools\Flash Programming Tool\DOS” directory to the root directory of a bootable USB key.
2. Navigate to your **Output Directory** (as specified in [Section 3.2](#) or [Section 2.6.2](#)) where your generated SPI Flash image(s) are saved. It is assumed that this image file is named **outimage.bin**. Copy this image file to the root directory of the USB key.
3. Boot the target system to DOS and change to the root directory of the bootable USB key. At the DOS prompt type:

```
fpt.exe /i
```

The system should respond with the number of SPI Flash devices available. For example:

```
--- Flash Devices Found ---  
W25Q64BV ID:0xEF4017 Size: 8192KB (65536Kb)  
W25Q64BV ID:0xEF4017 Size: 8192KB (65536Kb)
```

Note: If the SPI Flash device does not currently contain a descriptor it may report only a single device.

4. Program the SPI Flash image to the Flash device(s) by issuing the following command at the prompt:

```
fpt.exe /f outimage.bin
```

If the programming was successful, then the following message will be shown.

```
FPT Operation Passed
```

If the programming was **NOT** successful, then repeat this step to try again. If programming problems persist, then check the SPI Flash devices and platform hardware.

5. Execute a platform global reset using FPT -greset. Next go to [Section 3.3](#) to check the Intel® ME Firmware status.



3.2.1 FPT Windows* Version

The Windows* OS versions supported by FPT are: Windows* PE, Windows* XP SP2, Windows* Vista and Windows* 7. There are two versions of FPT for Windows*: a 32-bit version and a 64-bit version. Most Windows* OS, Windows* XP, Vista, Windows* 7 (32-bit or 64-bit) and Windows* 8 (32-bit or 64-bit) can use Windows* version of FPT. However, Windows* OS which do not support 32 bit compatible mode (Win PE 64-bit) **must use** FPT Windows* 64-bit version due to compatibility issues.

Use the following steps to program the SPI Flash devices,

1. Navigate to your **Output Directory** (as specified in [Section 3.2](#) or [Section 2.6.2](#)) where your generated SPI Flash image(s) are saved. It is assumed that this image file is named **outimage.bin**. Copy this image file to FPT directory located at "(root)\Tools\System Tools\Flash Programming Tool\Windows".
2. Boot the target system to Windows* and open a Command Prompt window. In this window, change to the FPT directory and at the prompt type:

```
fptw.exe /i
```

The system should respond with the number of SPI Flash devices available. For example:

```
--- Flash Devices Found ---
W25Q64BV ID:0xEF4017 Size: 8192KB (65536Kb)
W25Q64BV ID:0xEF4017 Size: 8192KB (65536Kb)
```

Note: If the SPI Flash device does not currently contain a descriptor it may report only a single device.

3. Program the SPI Flash image to the Flash device(s) by issuing the following command at the prompt:

```
fptw.exe /f outimage.bin
```

If the programming was successful, then the following message will be shown.

```
FPT Operation Passed
```

If the programming was **NOT** successful, then repeat this step to try again. If programming problems persist, then check the SPI Flash devices and platform hardware.

4. Power down the platform with a G3 power cycle (ensure all power is disconnected from the system). Next go to [Section 3.3](#) to check the Intel® ME Firmware status.

3.3 Checking Intel® ME Firmware Status

Use the following steps to check the platform health and Intel® ME FW status,

1. Copy the file **MEInfo.exe** in the "(root)\Tools\System Tools\MEInfo\DOS" directory to the root directory of a bootable USB key.



2. Boot the target system and stop at the BIOS setup menu. Load default values for BIOS (on Intel® CRBs press F3 to load default values). Save and reboot (on Intel® CRBs press F4 and select Yes).
3. Boot the target system to DOS and change to the root directory of the bootable USB key. At the DOS prompt type:

```
MEInfo.exe
```

The system should respond with a message similar to below.

```
Intel(R) MEInfo Version: 8.1.0.xxxx
Copyright(C) 2005 - 2011, Intel Corporation. All rights reserved.

Intel(R) Manageability and Security Application code versions:

BIOS Version:                ACRVMBY1.86C.0035.B00.1103131018
MEBx Version:                8.1.0.xx
Gbe Version:                 1.3
VendorID:                    8086
PCH Version:                 600000
FW Version:                  8.1.0.xxxx

FW Capabilities:            0x0DFE5C67

    Intel(R) Active Management Technology - PRESENT/ENABLED
    Intel(R) Anti-Theft Technology - PRESENT/ENABLED
    Intel(R) Capability Licensing Service - PRESENT/ENABLED
    Protect Audio Video Path - PRESENT/ENABLED
    Intel(R) ME Dynamic Application Loader - PRESENT/ENABLED

Intel(R) AMT State:          Enabled
CPU Upgrade State:          Upgrade Capable
Cryptography Support:       Enabled
Last ME reset reason:       Power up
Local FWUpdate:             Enabled
BIOS and GbE Config Lock:   Enabled
Host Read Access to ME:     Enabled
Host Write Access to ME:    Enabled
SPI Flash ID #1:            EF4017
SPI Flash ID VSCC #1:       20052005
BIOS boot State:            Post Boot
OEM Id:                     00000000-0000-0000-0000-000000000000
```

As in the above example if there are NO errors shown, then

- your platform's health is good
- Intel® ME FW has successfully initialized
- Intel® ME FW is operating normally

Note: This section is only intended to show how to use the MEInfo.exe tool for checking firmware status. For full usage and capabilities of the MEInfo.exe tool, please see the System Tools User Guide.



3.4 Common Bring Up Issues and Troubleshooting Table

Table 3-2. Common Bring Up Issues and Troubleshooting Table

Problem / Issue	Solution / Workaround
System does not boot to DOS	By default, the system will boot to EFI Shell. To boot to DOS, 1. Enter BIOS menu, then go to the 'Boot' screen 2. Change 'Boot Option #1' to be your USB key (ensure USB key is formatted to be DOS bootable) 3. Press 'F4' to save settings and reboot
Hear 3 beeps when platform powers on	Possible device is disconnected or device not found, check <ul style="list-style-type: none"> • platform power and CPU fan power connectors • DIMM memory modules • USB devices (keyboard, mouse, USB key) may be plugged into inactive USB port • missing/incorrect jumpers • missing CPU or PCH
No display on monitor	Ensure 1.5MB FW SKU supports integrated graphics. Try external graphics card.
USB device not detected or does not work	USB device may be plugged into inactive USB port
System does not boot (Post Code 00)	Incorrect Flash image – possible reasons: <ul style="list-style-type: none"> • wrong FW selected during Flash image build process • wrong Flash size selected Re-build image with correct settings and re-flash using Flash burner.

§ §

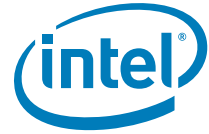

4 Intel® ME Firmware Features - Details and Settings

All parameters in this section are color-coded as per the key below.

The parameter can be changed
The parameter is read only and cannot be changed

Table 4-1. Feature Default Settings by 7 Series SKU (Desktop) (Sheet 1 of 2)

7 Series	Feature	Default Value
Intel® H77 - Desktop	Enable Intel® Standard Manageability; Disable Intel® AMT	Yes
	Managability Application Permanently Disabled?	No
	PAVP Permanently Disabled?	No
	TLS Permanently Disabled?	No
	Intel® Anti-Theft Technology Permanently Disabled?	No
	Intel® ME Network Services Permanently Disabled?	No
	mDNS Proxy Permanently Disabled?	Yes
	Intel® Manageability Application Enable / Disable	Enabled
Intel® Z77 - Desktop	Enable Intel® Standard Manageability; Disable Intel® AMT	Yes
	Managability Application Permanently Disabled?	Yes
	PAVP Permanently Disabled?	No
	TLS Permanently Disabled?	Yes
	Intel® Anti-Theft Technology Permanently Disabled?	No
	Intel® ME Network Services Permanently Disabled?	No
	mDNS Proxy Permanently Disabled?	Yes
	Intel® Manageability Application Enable / Disable	Disabled
Intel® Z75 - Desktop	Enable Intel® Standard Manageability; Disable Intel® AMT	Yes
	Managability Application Permanently Disabled?	Yes
	PAVP Permanently Disabled?	No
	TLS Permanently Disabled?	Yes
	Intel® Anti-Theft Technology Permanently Disabled?	No
	Intel® ME Network Services Permanently Disabled?	No
	mDNS Proxy Permanently Disabled?	Yes
	Intel® Manageability Application Enable / Disable	Disabled

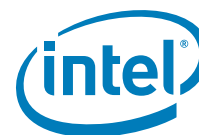

Table 4-1. Feature Default Settings by 7 Series SKU (Desktop) (Sheet 2 of 2)

7 Series	Feature	Default Value
Intel® H71 - Desktop	Enable Intel® Standard Manageability; Disable Intel® AMT	Yes
	Managability Application Permanently Disabled?	Yes
	PAVP Permanently Disabled?	No
	TLS Permanently Disabled?	Yes
	Intel® Anti-Theft Technology Permanently Disabled?	No
	Intel® ME Network Services Permanently Disabled?	No
	mDNS Proxy Permanently Disabled?	Yes
	Intel® Manageability Application Enable / Disable	Disabled



All parameters in this section are color-coded as per the key below.

The parameter can be changed
The parameter is read only and cannot be changed

Table 4-2. Feature Default Settings by 6 Series SKU (Desktop)

6 Series	Feature	Default Value
Intel® H67 - Desktop	Enable Intel® Standard Manageability; Disable Intel® AMT	Yes
	Managability Application Permanently Disabled?	No
	PAVP Permanently Disabled?	No
	TLS Permanently Disabled?	No
	Intel® Anti-Theft Technology Permanently Disabled?	Yes
	Intel® ME Network Services Permanently Disabled?	No
	mDNS Proxy Permanently Disabled?	Yes
	Intel® Manageability Application Enable / Disable	Enabled
Intel® Z68 - Desktop	Enable Intel® Standard Manageability; Disable Intel® AMT	Yes
	Managability Application Permanently Disabled?	Yes
	PAVP Permanently Disabled?	No
	TLS Permanently Disabled?	Yes
	Intel® Anti-Theft Technology Permanently Disabled?	Yes
	Intel® ME Network Services Permanently Disabled?	No
	mDNS Proxy Permanently Disabled?	Yes
	Intel® Manageability Application Enable / Disable	Disabled
Intel® P67 - Desktop	Enable Intel® Standard Manageability; Disable Intel® AMT	Yes
	Managability Application Permanently Disabled?	Yes
	PAVP Permanently Disabled?	Yes
	TLS Permanently Disabled?	Yes
	Intel® Anti-Theft Technology Permanently Disabled?	Yes
	Intel® ME Network Services Permanently Disabled?	No
	mDNS Proxy Permanently Disabled?	Yes
	Intel® Manageability Application Enable / Disable	Disabled
Intel® H61 - Desktop	Enable Intel® Standard Manageability; Disable Intel® AMT	Yes
	Managability Application Permanently Disabled?	Yes
	PAVP Permanently Disabled	No
	TLS Permanently Disabled?	Yes
	Intel® Anti-Theft Technology Permanently Disabled?	Yes
	Intel® ME Network Services Permanently Disabled?	No
	mDNS Proxy Permanently Disabled?	Yes
	Intel® Manageability Application Enable / Disable	Disabled

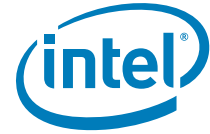

All parameters in this section are color-coded as per the key below.

The parameter can be changed
The parameter is read only and cannot be changed

Table 4-3. Feature Default Settings by 7 Series SKU (Mobile) (Sheet 1 of 2)

7 Series	Feature	Default Value
Intel® UM77 - Mobile	Enable Intel® Standard Manageability; Disable Intel® AMT	Yes
	Managability Application Permanently Disabled?	Yes
	PAVP Permanently Disabled?	No
	TLS Permanently Disabled?	Yes
	Intel® Anti-Theft Technology Permanently Disabled?	No
	Intel® ME Network Services Permanently Disabled?	No
	mDNS Proxy Permanently Disabled?	Yes
	Intel® Manageability Application Enable / Disable	Disabled
Intel® HM77 - Mobile	Enable Intel® Standard Manageability; Disable Intel® AMT	Yes
	Managability Application Permanently Disabled?	No
	PAVP Permanently Disabled?	No
	TLS Permanently Disabled?	No
	Intel® Anti-Theft Technology Permanently Disabled?	No
	Intel® ME Network Services Permanently Disabled?	No
	mDNS Proxy Permanently Disabled?	Yes
	Intel® Manageability Application Enable / Disable	Enabled
Mobile Intel® UM77 Express Chipset	Enable Intel® Standard Manageability; Disable Intel® AMT	Yes
	Manageability Application Permanently Disabled?	No
	PAVP Permanently Disabled?	No
	KVM Permanently Disabled?	No
	TLS Permanently Disabled?	No
	Intel® Anti-Theft Technology Permanently Disabled?	No
	Intel® ME Network Services Permanently Disabled?	No
	mDNS Proxy Permanently Disabled?	Yes
	Intel® Manageability Application Enable / Disable	Enabled
Intel® HM77 - Mobile	Enable Intel® Standard Manageability; Disable Intel® AMT	Yes
	Managability Application Permanently Disabled?	No
	PAVP Permanently Disabled?	No
	KVM Permanently Disabled?	No
	TLS Permanently Disabled?	No
	Intel® Anti-Theft Technology Permanently Disabled?	No
	Intel® ME Network Services Permanently Disabled?	No
	mDNS Proxy Permanently Disabled?	Yes
Intel® Manageability Application Enable / Disable	Enabled	



Table 4-3. Feature Default Settings by 7 Series SKU (Mobile) (Sheet 2 of 2)

7 Series	Feature	Default Value
Intel® HM76 - Mobile	Enable Intel® Standard Manageability; Disable Intel® AMT	Yes
	Managability Application Permanently Disabled?	No
	PAVP Permanently Disabled?	No
	TLS Permanently Disabled?	No
	Intel® Anti-Theft Technology Permanently Disabled?	No
	Intel® ME Network Services Permanently Disabled?	No
	mDNS Proxy Permanently Disabled?	Yes
	Intel® Manageability Application Enable / Disable	Enabled
Intel® HM75 - Mobile	Enable Intel® Standard Manageability; Disable Intel® AMT	Yes
	Managability Application Permanently Disabled?	No
	PAVP Permanently Disabled?	No
	TLS Permanently Disabled?	No
	Intel® Anti-Theft Technology Permanently Disabled?	No
	Intel® ME Network Services Permanently Disabled?	No
	mDNS Proxy Permanently Disabled?	Yes
	Intel® Manageability Application Enable / Disable	Enabled
Intel® QS77 - Mobile	Enable Intel® Standard Manageability; Disable Intel® AMT	No
	Managability Application Permanently Disabled?	No
	PAVP Permanently Disabled?	No
	KVM Permanently Disabled?	No
	TLS Permanently Disabled?	No
	Intel® Anti-Theft Technology Permanently Disabled?	No
	Intel® ME Network Services Permanently Disabled?	No
	mDNS Proxy Permanently Disabled?	Yes
Intel® Manageability Application Enable / Disable	Enabled	
Intel® HM70 - Mobile	Enable Intel® Standard Manageability; Disable Intel® AMT	Yes
	Managability Application Permanently Disabled?	No
	PAVP Permanently Disabled?	No
	TLS Permanently Disabled?	No
	Intel® Anti-Theft Technology Permanently Disabled?	No
	Intel® ME Network Services Permanently Disabled?	No
	mDNS Proxy Permanently Disabled?	Yes
	Intel® Manageability Application Enable / Disable	Enabled



All parameters in this section are color-coded as per the key below.

The parameter can be changed
The parameter is read only and cannot be changed

Table 4-4. Feature Default Settings by 6 Series SKU (Mobile)

6 Series	Feature	Default Value
Intel® HM67 - Mobile	Enable Intel® Standard Manageability; Disable Intel® AMT	Yes
	Managability Application Permanently Disabled?	No
	PAVP Permanently Disabled?	No
	TLS Permanently Disabled?	No
	Intel® Anti-Theft Technology Permanently Disabled?	No
	Intel® ME Network Services Permanently Disabled?	No
	mDNS Proxy Permanently Disabled?	Yes
	Intel® Manageability Application Enable / Disable	Enabled
Intel® HM65 - Mobile	Enable Intel® Standard Manageability; Disable Intel® AMT	Yes
	Managability Application Permanently Disabled?	No
	PAVP Permanently Disabled?	No
	TLS Permanently Disabled?	No
	Intel® Anti-Theft Technology Permanently Disabled?	No
	Intel® ME Network Services Permanently Disabled?	No
	mDNS Proxy Permanently Disabled?	Yes
	Intel® Manageability Application Enable / Disable	Enabled
Intel® QS67 - Mobile	Enable Intel® Standard Manageability; Disable Intel® AMT	No
	Managability Application Permanently Disabled?	No
	PAVP Permanently Disabled?	No
	TLS Permanently Disabled?	No
	Intel® Anti-Theft Technology Permanently Disabled?	No
	Intel® ME Network Services Permanently Disabled?	No
	mDNS Proxy Permanently Disabled?	Yes
	Intel® Manageability Application Enable / Disable	Enabled
Intel® UM67 - Mobile	Enable Intel® Standard Manageability; Disable Intel® AMT	No
	Managability Application Permanently Disabled?	No
	PAVP Permanently Disabled?	No
	TLS Permanently Disabled?	No
	Intel® Anti-Theft Technology Permanently Disabled?	No
	Intel® ME Network Services Permanently Disabled?	No
	mDNS Proxy Permanently Disabled?	Yes
	Intel® Manageability Application Enable / Disable	Enabled



4.1 Deep Sx Settings

This chapter covers configuration settings for the Intel® 7 Series/C216 Chipset Family based Desktop and Mobile CRB platforms Deep Sx operation.

Table 4-5. Deep Sx Settings for Desktop CRB

Desktop boards without F18 rework	Option	Settings
DeepSx Disabled		
FITC Strap 10	DeepSx	False
BIOS	Advanced -> PCH-IO Configuration-> DeepSx Power Policies	Disabled
Desktop boards with F18 rework	Option	Settings
DeepSx Enabled		
FITC Strap 10	DeepSx	True
BIOS	Advanced -> PCH-IO Configuration-> DeepSx Power Policies	Enabled in S5 or Enabled in S4-S5
DeepSx Disabled		
FITC Strap 10	DeepSx	True
BIOS	Advanced -> PCH-IO Configuration-> DeepSx Power Policies	Disabled

Table 4-6. Deep Sx Settings for Mobile CRB

Mobile boards without DSW rework	Option	Settings
DeepSx Disabled		
FITC Strap 10	DeepSx	False
BIOS	Advanced -> PCH-IO Configuration-> DeepSx Power Policies	Disabled
Mobile boards with DSW rework and KSC >= 1.02	Option	Settings
DeepSx Enabled		
FITC Strap 10	DeepSx	True
BIOS	Advanced -> PCH-IO Configuration-> DeepSx Power Policies	Enabled in S5/Battery or Enabled in S4-S5/Battery
DeepSx Disabled		
FITC Strap 10	DeepSx	True
BIOS	Advanced -> PCH-IO Configuration-> DeepSx Power Policies	Disabled

Mobile Notes:

1. The EC will default to legacy SUS_PWR_DN_ACK mode when you disable DeepSx in BIOS.
2. DeepSx will not work with ATX power supply so you must disable DeepSx in both the strap and BIOS if you want to use ATX.

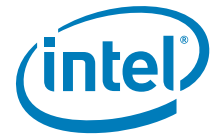

Behavior on Mobile CRB Boards

1. DSW LED will turn on when SLP_SUS# is asserted
 - a. When entering DeepSx
 - b. When EC powers down SUS due to SUS_PWR_DN_ACK
 - c. SLP_SUS# goes low due to RSMRST# assertion, even if SLP_SUS# is not connected
2. The LED is labeled as "DSW", located next to the ATX power socket.

Behavior on Desktop CRB Boards

1. If DeepSx is enabled, SLP_SUS_N LED will turn off.
2. The LED is located right next to the PostCode Display, with Orange light, labeled as "SLP_SUS_N" CR47EV.

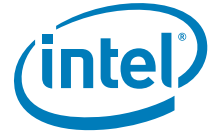

4.2 Wireless LAN Configuration

The following table outlines the correct Intel® Mobile CRB - Emerald Lake 2 jumper settings for Wireless LAN functionality.

Note: To ensure proper Intel® ME functionality with the Wireless LAN adapter make sure that the correct Wireless LAN micro code for that adapter is selected in the Intel® ME Region options.

Table 4-7. WLAN Jumper settings

CRB Jumpers			
J7B2		J7D1	
Correct	3 2 1 	Correct	3 2 1
Incorrect	3 2 1 	Incorrect	3 2 1

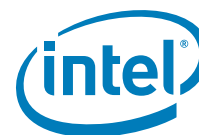

A Appendix — Flash Configurations

This chapter covers only the basic information needed for clock control parameter programming. For a more detailed treatment of Panther Point clocks, see *Intel® 7 Series/C216 Chipset Family Platform Clocks* and *Intel® Management Engine — Platform Compliancy Guide for ME Hardware*.

Figure A-1. Configuration “A” — Desktop/Server/Workstation or Mobile

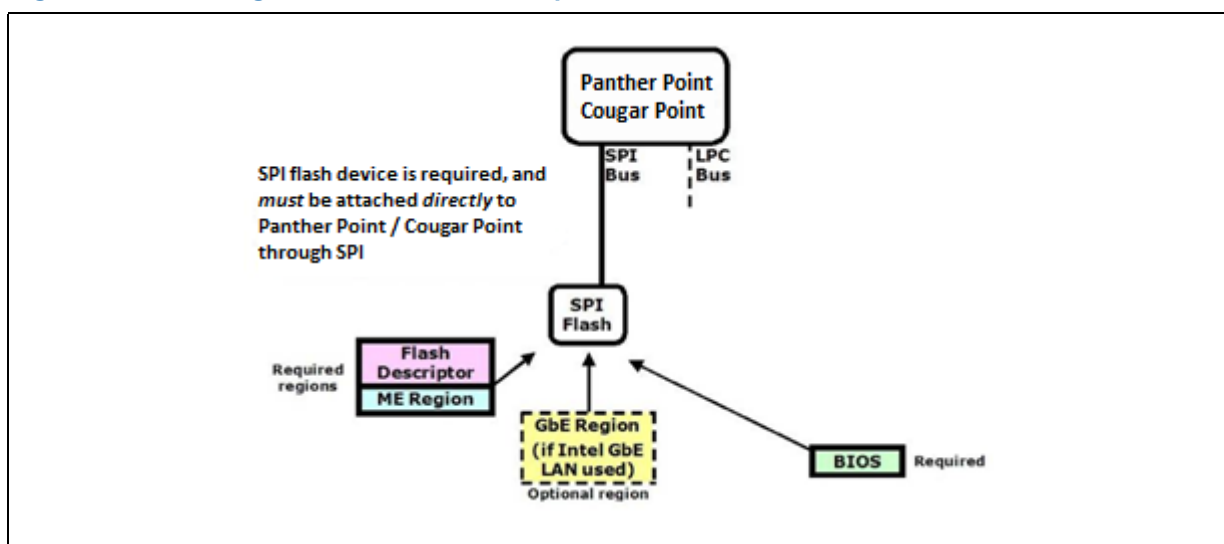

Figure A-2. Configuration “B” — Mobile Only

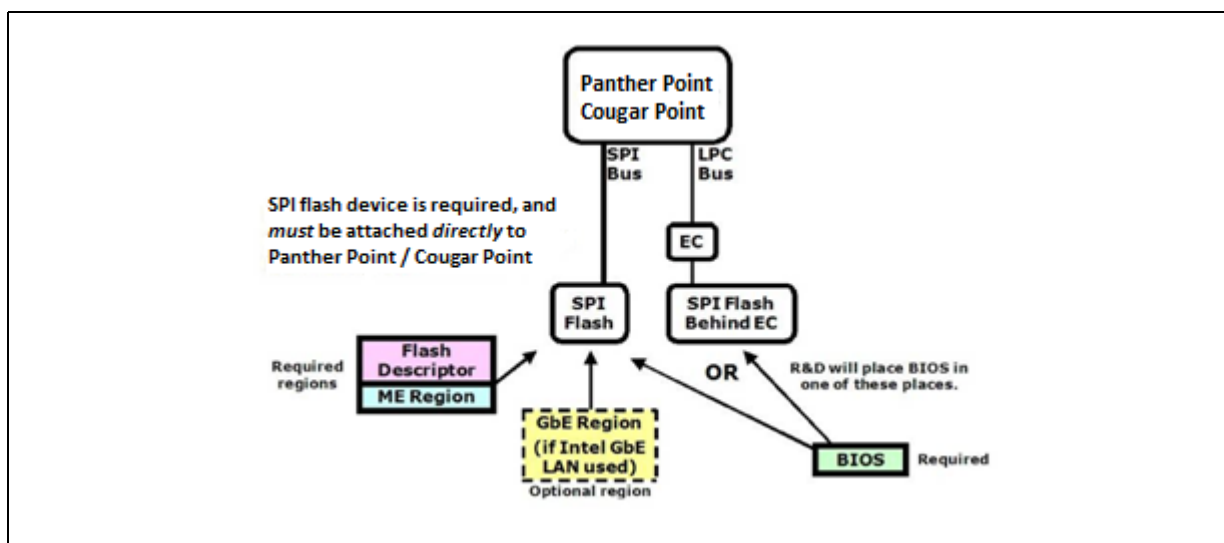



Figure A-3. Configuration “C” — Desktop/Server/Workstation Only

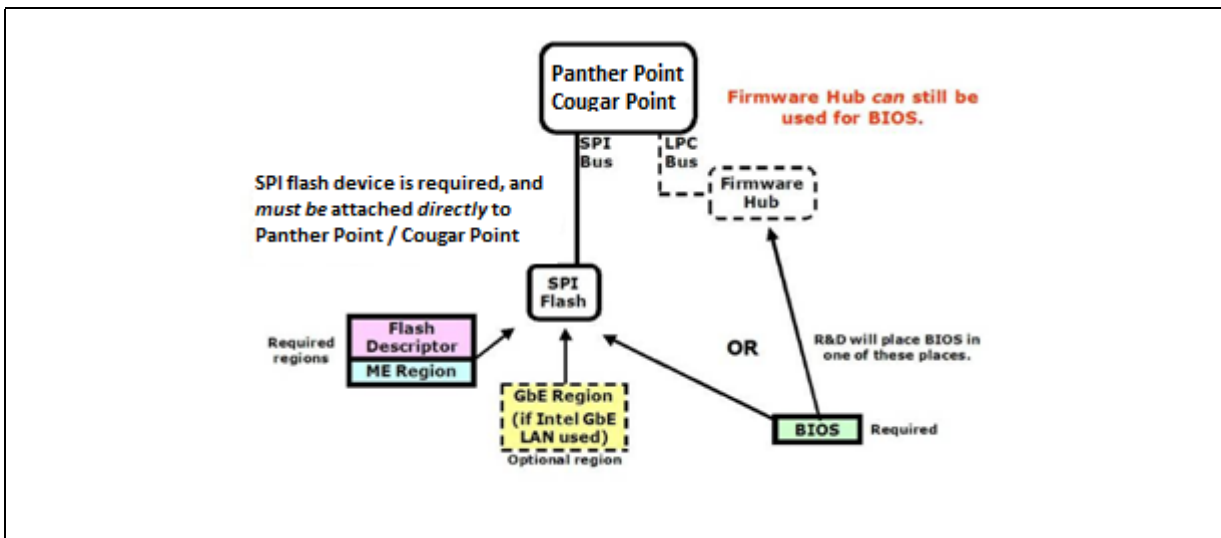
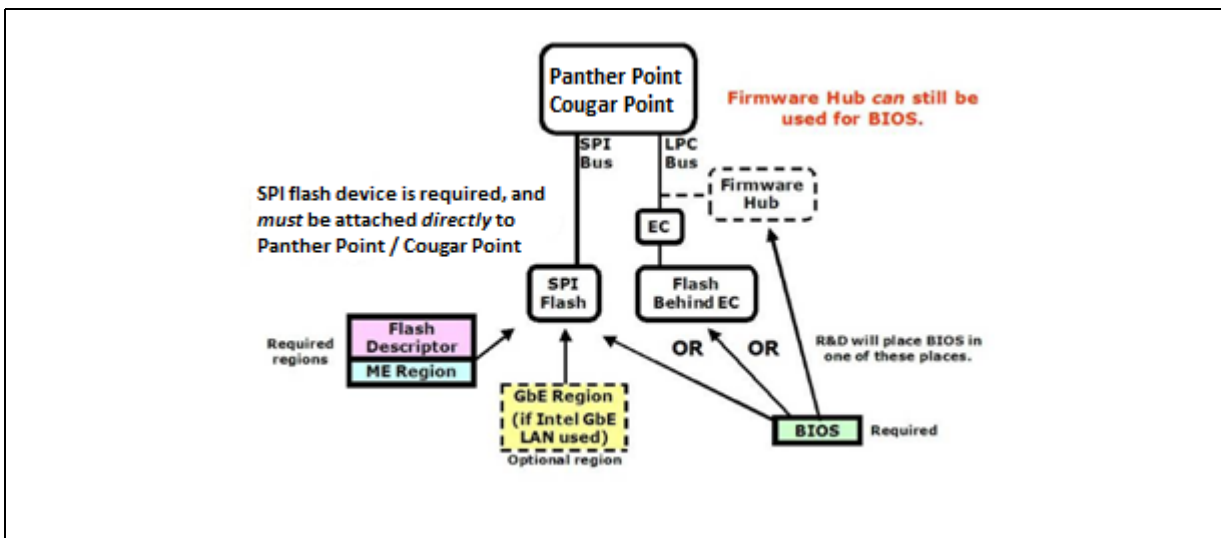
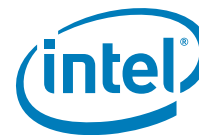

Figure A-4. Configuration “D” — Mobile Only



§ §



B Appendix — Intel® 7 Series/C216 Chipset Family Clock Configuration

This chapter covers only the basic information needed for clock control parameter programming. For more information on validating and checking compliancy for PCH clocks, see *Intel® 7 Series/C216 Chipset Family Intel® Management Engine — Compliancy Guide*.

Figure B-1. Intel® 7 Series/C216 Chipset Family Full Clock Integration Mode Architecture

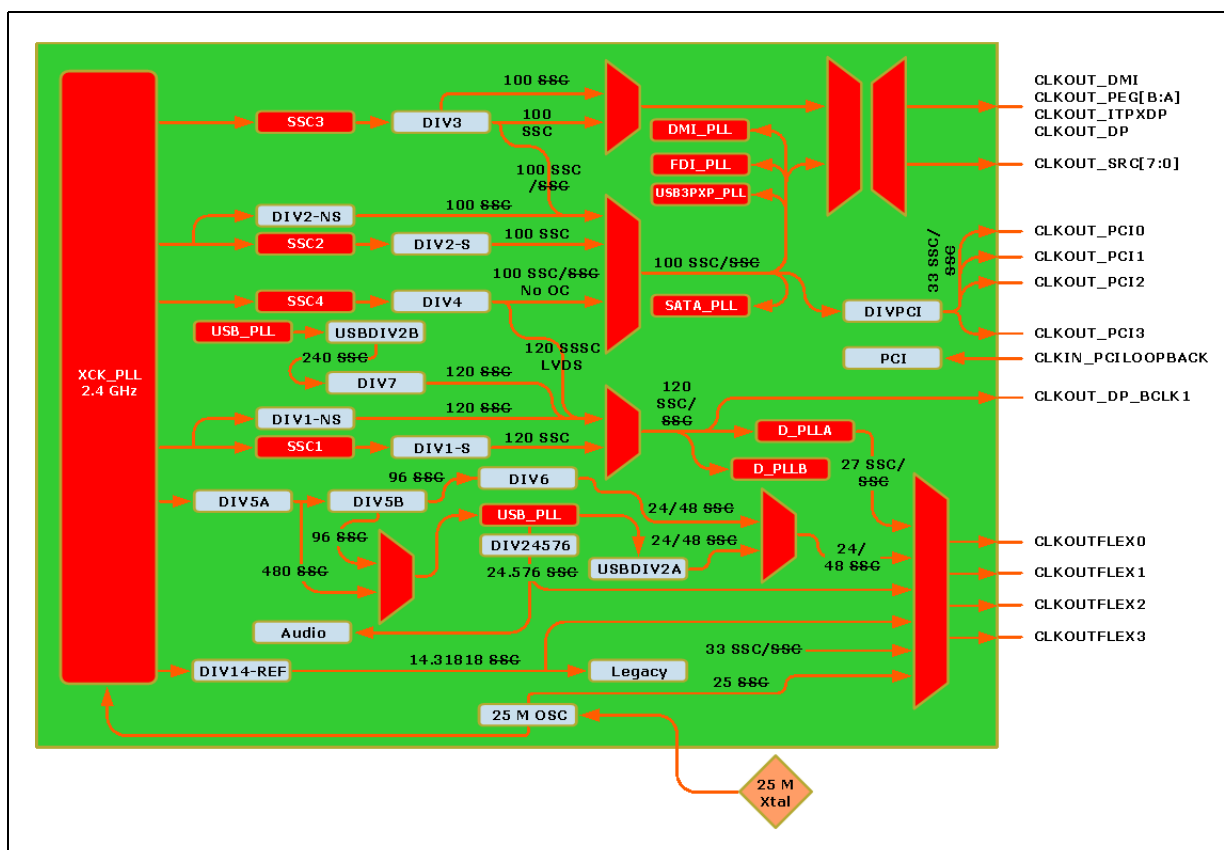

Note: 14.31818, 24, 25, 27 with SSC, 27 without SSC, and 48 MHz outputs are guaranteed from CLKOUTFLEX[3:0]. 25-MHz output cannot be used to supply Intel® LAN. 27 with SSC, 27 without SSC clocks are available in PCH hardware, but are not extensively tested or recommended for use.



B.1 Functional Blocks

There are 4 spread modulator in PCH, labeled as follows:

Table B-1. SSC Blocks

Modulator	Description
SSC1	Generates single phase 2.4-GHz output with spread for 120-MHz clock with spread generation by DIV1-S. Uses 2.4-GHz output of XCK PLL. Supplies CLKOUT_DP.
SSC2	Generates single phase 2.4-GHz output with spread for 100-MHz clock with spread and overclocking option generation by DIV2-S. Uses 2.4-GHz output of XCK PLL. Non-Overclocking: Supplies CLKOUT_DMI, CLKOUT_PEG[B:A], CLKOUT_ITPXDP, CLKOUT_SRC[7:0], and SATA. Indirectly supplies CLKOUT_PCI[4:0] and CLKOUTFLEX[3:0]. Overclocking: Supplies CLKOUT_DMI, CLKOUT_PEG[B:A], and CLKOUT_ITPXDP only.
SSC3	Generates single phase 2.4-GHz output with spread for 100-MHz clock with spread and overclocking option generation by DIV3. Uses 2.4-GHz output of XCK PLL. Non-Overclocking: Disabled Overclocking: Supplies CLKOUT_SRC[7:0] and SATA. Indirectly supplies CLKOUT_PCI[4:0] and CLKOUTFLEX[3:0].
SSC4	Generates single phase 2.4-GHz output with spread for 120-MHz clock with spread and no overclocking option generation by DIV4. Uses 2.4-GHz output of XCK PLL. Non-Overclocking: Supplies SSSC clock for LVDS. Overclocking (some configurations): Supplies SATA.

Note: By default, all the SSC blocks are configured to generate a spread spectrum of 0.5% down spread mode.

There are various clock dividers in PCH, labeled as follows:

Table B-2. Clock Dividers (Sheet 1 of 2)

Modulator	Description
DIV1-NS	Generates 120-MHz clock with no spread. Uses direct 2.4-GHz output of XCK PLL (not passed through SSC1). Supplies CLKOUT_DP.
DIV1-S	Generates 120-MHz clock with spread. Uses output of SSC1. Can be no spread if SSC1 is disabled. Supplies CLKOUT_DP.
DIV2-NS	Generates 100-MHz with no spread and overclocking option. Uses direct 2.4-GHz output of XCK PLL (not passed through SSC2). Disabled in all ME FW configurations.
DIV2-S	Generates 100-MHz with spread and overclocking option. Uses output of SSC2. Can be no spread if SSC2 is disabled. Non-Overclocking: Supplies CLKOUT_DMI, CLKOUT_PEG[B:A], CLKOUT_ITPXDP, CLKOUT_SRC[7:0]. Indirectly supplies CLKOUT_PCI[4:0], SATA, and CLKOUTFLEX[3:0]. Overclocking: Supplies CLKOUT_DMI, CLKOUT_PEG[B:A], CLKOUT_ITPXDP only.
DIV3	Generates 100-MHz with spread. Generally not expected to be overclocked. Uses output of SSC3. Can be no spread if SSC3 is disabled. Non-Overclocking: Disabled Overclocking: Supplies CLKOUT_SRC[7:0] only. Indirectly supplies CLKOUT_PCI[4:0], SATA, and CLKOUTFLEX[3:0].
DIV4	Generates 120-MHz clock with spread. Uses output of SSC4. Can be no spread if SSC4 is disabled. Supplies SATA. May also supply SSSC option for LVDS and utilized for Display Clock Bending.
DIV5A	Generates 480-MHz clock which is then converted to 96-MHz clock by USBDIV1 (not shown). Uses 2.4-GHz output of XCK PLL. Supplies USBDIV1.
DIV5B	Generates 96-MHz clock. Uses output of DIV5A. Supplies USB PLL.



Table B-2. Clock Dividers (Sheet 2 of 2)

Modulator	Description
DIV6	Generates 48-Mhz or 24-MHz clock with no spread. Uses output of DIV5B. Supplies CLKOUTFLEX3.
DIV7	Generates 120-MHz clock with no spread. Uses output of USBDIV2B. Supplies CLKOUT_DP.
USBDIV1	Generates 96-MHz clock with no spread. Uses output of DIV5A. Supplies USB PLL.
USBDIV2A	Generates 24- or 48-MHz clock with no spread. Uses 96-MHz output of DIV5B or USBDIV1 (not shown). Supplies CLKOUTFLEX3.
USBDIV2B	Generates 240-MHz clock with no spread. Uses USB PLL's 1.92 GHz clock output. Supplies DIV7.
DIVPCI	Generates 33-MHz clock with spread. Uses output of either DIV2-S, DIV2-NS, or DIV4. Can be no spread if DIV2-NS is used or SSC4 is disabled. Supplies CLKOUT_PCI[4:0] and CLKOUTFLEX[3:0].
DIV14-REF	Generates 14.318 MHz clock with no spread. Uses 2.4-GHz output of XCK PLL. Supplies CLKOUTFLEX[3:0].

B.2 Clock Configuration XML

Note: The use of ICC Configuration XML has been deprecated. Configuration of ICC parameters are no longer available via separate XML file. The Flash Image Tool GUI can be used to edit ICC parameters.

B.3 Intel® ME FW Clock Control Parameters

The following parameters can be specified for Intel® ME FW programming. For more details on how to configure an SPI Flash image with these clock control parameters see the Bring Up Process chapter in the *Firmware Bring Up Guide* included in the Intel® ME FW kit.

B.3.1 CSS – Clock Source Select

Address Offset: 0x00h

Flash Image Tool/ME FW Default for FCIM: 0001_1A33h
Recommended Overclocking Default for FCIM: 0001_1A34h
FCIM HW Default: 0001_1A12h

Description: This parameter controls clock source selection for non-PCI Express* clocks.

Flash Image Tool Configuration: Available in **ME Region | Configuration | ICC Data | ICC Profile 0 | FCIM/BTM Specific Registers**



Table B-3. Clock Source Select Parameters

Bits	Default	Description
31:17	0h	Reserved (RSVD)
16:12	10001b	Chipset Configuration (PCHCFG): As specified by clock mode.
11:10	10b	<p>24MHz/48MHz clock source select (24x48CSS): This field selects the source of 24/48 MHz clock used as a possible source for CLKOUTFLEX outputs. See “FLEXCLK[3:0] Source Select” parameters at FCSS (see Section B.3.3).</p> <p>0xb = Reserved 10b = 48 MHz generated from XCK_PLL output divide 11b = 24 MHz generated from XCK_PLL output divide</p>
9:3	HW: 42h ME FW: 46h FITC: 46h	Chipset Configuration (PCHCFG): As specified by clock mode.
2:0	<p>FCIM HW: 010b ME FW: 011b FITC: 011b</p> <p>FCIM Overclocking FITC: 100b</p>	<p>PCI Clock Source Select (PCSS): This field selects the source of 33-MHz clock used as a source for CLKOUT_PCI and CLKOUTFLEX outputs.</p> <p>FCIM 011b = SSC2 spread (non-overclocking option)</p> <p>FCIM Overclocking 100b = SSC3 (overclocking option) all other values = Reserved</p> <p>Note: FCIM overclocking requires a parameter value different from FCIM ME FW defaults. Note: Spread spectrum can be turned on and off for SSC[3:2] using “SSC[3:2] Enable, Active Low” parameters at SSCCTL[16,8] (see Section B.3.15).</p>

B.3.2 SSS – SRC Source Select

Address Offset: 0x01h

Flash Image Tool/ME FW Default for FCIM: No changes from HW defaults

Recommended Overclocking Default for FCIM: 0013_3744h

FCIM HW Default: 0003_3733h

Description: This parameter controls clock source selection for PCI Express* clocks.

Flash Image Tool Configuration: Available in **ME Region | Configuration | ICC Data | ICC Profile 0 | FCIM/BTM Specific Registers**



Table B-4. SRC Source Select Parameters

Bits	Default	Description
31:21	0h	Reserved (RSVD)
20	FCIM 0b FCIM Overclocking 1b	DMI Port Clock Select (DMIPORTCS): Selects PLL source for of 100-MHz clock used as a source for CLKOUT_DMI, CLKOUT_PEG_[B:A], and CLKOUT_ITPXDP outputs. FCIM 0b = Non-overclockable PXP PLL all other values = Reserved FCIM Overclocking 1b = Overclockable DMI PLL all other values = Reserved Note: FCIM overclocking requires a parameter value different from FCIM ME FW defaults. Note: 100-MHz clock used as a source for CLKOUT_SRC[7:0], and 33-MHz clock used as a source for CLKOUT_PCI[4:0] and CLKOUTFLEX[3:0] are always sourced from non-overclockable PXP PLL.
19	0b	Reserved (RSVD)
18:7	66Eh	Chipset Configuration (PCHCFG): As specified by clock mode.
6:4	FCIM 011b FCIM Overclocking 100b	SRC[7:4] Clock Source Select (SRC74CSS): This field selects the source of 100-MHz clock used as a source for CLKOUT_SRC[7:4] outputs. FCIM 011b = SSC2 spread (non-overclocking option) FCIM Overclocking 100b = SSC3 (overclocking option) all other values = Reserved Note: FCIM overclocking requires a parameter value different from FCIM ME FW defaults. Note: Spread spectrum can be turned on and off for SSC[3:2] using "SSC[3:2] Enable, Active Low" parameters at SSCCTL[16,8] (see Section B.3.15).
3	0b	Reserved (RSVD)
2:0	FCIM 011b FCIM Overclocking FITC: 100b	SRC[3:0] Clock Source Select (SRC30CSS): This field selects the source of 100-MHz clock used as a source for CLKOUT_SRC[3:0] outputs. FCIM 011b = SSC2 spread (non-overclocking option) FCIM Overclocking 100b = SSC3 (overclocking option) all other values = Reserved Note: FCIM overclocking requires a parameter value different from FCIM ME FW defaults. Note: Spread spectrum can be turned on and off for SSC[3:2] using "SSC[3:2] Enable, Active Low" parameters at SSCCTL[16,8] (see Section B.3.15).

B.3.3 FCSS – Flex Clock Source Select

Address Offset: 0x02h

Flash Image Tool/ME FW Default: 0000_0232h

HW Default: 0000_0304h

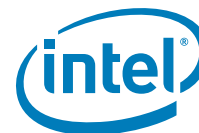

Description: This parameter controls muxing to select sources for Flex Clock outputs.
Flash Image Tool Configuration: Available in **ME Region | Configuration | ICC Data | ICC Profile 0 | ICC Registers**

- Note:** For clock signal integrity reasons related to PCH power-related jitter, it is extremely important to follow the Flex Clock configuration guidelines:
- Prioritize 27/14/24/48/25-MHz FLEX on FLEX1 and FLEX3
 - Do not configure 27/14/24/48/25-MHz FLEX clock on FLEX0 and FLEX2 if more than 2 PCI clocks + PCI loopback are routed.
 - With 2 PCI clocks routed (or less), prioritize the FLEX clocks to FLEX1 and FLEX3 in this order (ie: first in the list = first to go to FLEX1 or FLEX3):
 - 27 MHz Non-SSC and 27 MHz SSC
 - 14.31818 MHz
 - 48 MHz or 24 MHz or 25 MHz

Note: 27 with SSC, and 27 without SSC clocks are available in PCH hardware, but are not extensively tested by Intel® and are not recommended for use.

Table B-5. Flex Clock Source Select Parameters (Sheet 1 of 3)

Bits	Default	Description
31:15	0h	Reserved (RSVD)
14:12	000b	<p>FLEXCLK3 Source Select (F3SS): Selects the source of clock to be driven out on CLKOUTFLEX3.</p> <p>000b = 24/48 MHz (24 or 48 determined by “24-MHz/48-MHz clock source” parameter at CSS[11:10], see Section B.3.1)</p> <p>001b = 27 MHz Non-SSC, from DPLL B</p> <ul style="list-style-type: none"> — Requires “DPLLA/DPLL B/SSC1 Ownership” parameter at PLEN[9] = 1b (see Section B.3.5) — Requires “DPLL B VCO Enable” parameter at DPLLBC[30] = 1b <p>010b = Reserved</p> <p>011b = 14.31818 MHz</p> <p>100b = Disabled (DC logic ‘0’)</p> <p>101b = 27 MHz SSC, from DPLLA</p> <ul style="list-style-type: none"> — Requires “DPLLA/DPLL B/SSC1 Ownership” parameter at PLEN[9] = 1b (see Section B.3.5) — Requires “DPLLA VCO Enable” parameter at DPLLAC[30] = 1b — Requires “DPLLA Reference Select” parameter at DPLLAC[26:24] = 011b <p>110b = Disabled (DC logic ‘0’)</p> <p>111b = Reserved</p> <p>Note: 27 with SSC, and 27 without SSC clocks are available in PCH hardware, but are not extensively tested Intel® and are not recommended for use.</p> <p>Note: This parameter field also controls the gating of 27-MHz clock source from DPLL B. When this clock is not being used, it is automatically gated off for power savings. When either “FLEXCLK3 or 2 Source Select” parameter field is set to 001b, 27-MHz clock from DPLL B is enabled and not gated.</p> <p>Note: These clock select settings only take effect when this muxed FLEXCLK/GPIO pin is configured for FLEXCLK native usage. Refer to the <i>Intel® 7 Series / 216 Chipset Family EDS</i> for configuration of GPIO vs. native usage.</p>
11	0b	Reserved (RSVD)



Table B-5. Flex Clock Source Select Parameters (Sheet 2 of 3)

Bits	Default	Description
10:8	011b	<p>FLEXCLK2 Source Select (F2SS): Selects the source of clock to be driven out on CLKOUTFLEX2.</p> <p>000b = 25 MHz from XCK PLL feedback path 001b = 27 MHz Non-SSC, from DPLL B — Requires “DPLLA/DPLL B/SSC1 Ownership” parameter at PLEN[9] = 1b (see Section B.3.5) — Requires “DPLL B VCO Enable” parameter at DPLLC[30] = 1b</p> <p>010b = 33.3 MHz 011b = 14.31818 MHz 100b = 24/48 MHz (24 or 48 determined by “24-MHz/48-MHz clock source” parameter at CSS[11:10], see Section B.3.1) 101b = 27 MHz SSC, from DPLLA — Requires “DPLLA/DPLL B/SSC1 Ownership” parameter at PLEN[9] = 1b (see Section B.3.5) — Requires “DPLLA VCO Enable” parameter at DPLLC[30] = 1b — Requires “DPLLA Reference Select” parameter at DPLLC[26:24] = 011b</p> <p>110b = Disabled (DC logic ‘0’) 111b = Reserved</p> <p>Note: 27 with SSC, and 27 without SSC clocks are available in PCH hardware, but are not extensively tested Intel® and are not recommended for use.</p> <p>Note: These clock select settings only take effect when this muxed FLEXCLK/GPIO pin is configured for FLEXCLK native usage. Refer to the <i>Intel® 7 Series / 216 Chipset Family EDS</i> for configuration of GPIO vs. native usage.</p>
7	0b	Reserved (RSVD)



Table B-5. Flex Clock Source Select Parameters (Sheet 3 of 3)

Bits	Default	Description
6:4	000b	<p>FLEXCLK1 Source Select (F1SS): Selects the source of clock to be driven out on CLKOUTFLEX1.</p> <p>000b = 001b = Reserved 010b = 011b = 14.31818 MHz 100b = 24/48 MHz (24 or 48 determined by “24-MHz/48-MHz clock source” parameter at CSS[11:10], see Section B.3.1) 101b = 27 MHz SSC, from DPLLA — Requires “DPLLA/DPLL/SSC1 Ownership” parameter at PLEN[9] = 1b (see Section B.3.5) — Requires “DPLLA VCO Enable” parameter at DPLLAC[30] = 1b — Requires “DPLLA Reference Select” parameter at DPLLAC[26:24] = 011b 110b = 27 MHz Non-SSC, from DPLLB — Requires “DPLLA/DPLL/SSC1 Ownership” parameter at PLEN[9] = 1b (see Section B.3.5) — Requires “DPLLB VCO Enable” parameter at DPLLBC[30] = 1b 111b = Reserved</p> <p>Note: 27 with SSC, and 27 without SSC clocks are available in PCH hardware, but are not extensively tested Intel® and are not recommended for use.</p> <p>Note: These clock select settings only take effect when this muxed FLEXCLK/GPIO pin is configured for FLEXCLK native usage. Refer to the <i>Intel® 7 Series / 216 Chipset FamilyEDS</i> for configuration of GPIO vs. native usage.</p>
3	0b	Reserved (RSVD)
2:0	100b	<p>FLEXCLK0 Source Select (FOSS): Selects the source of clock to be driven out on CLKOUTFLEX0.</p> <p>000b = 27 MHz SSC, from DPLLA — Requires “DPLLA/DPLL/SSC1 Ownership” parameter at PLEN[9] = 1b (see Section B.3.5) — Requires “DPLLA VCO Enable” parameter at DPLLAC[30] = 1b — Requires “DPLLA Reference Select” parameter at DPLLAC[26:24] = 011b 001b = Reserved 010b = 33.3 MHz 011b = 14.31818 MHz 100b = 24/48 MHz (24 or 48 determined by “24-MHz/48-MHz clock source” parameter at CSS[11:10], see Section B.3.1) 101b = Disabled (DC logic ‘0’) 110b = 27 MHz Non-SSC, from DPLLB — Requires “DPLLA/DPLL/SSC1 Ownership” parameter at PLEN[9] = 1b (see Section B.3.5) — Requires “DPLLB VCO Enable” parameter at DPLLBC[30] = 1b 111b = Reserved</p> <p>Note: 27 with SSC, and 27 without SSC clocks are available in PCH hardware, but are not extensively tested Intel® and are not recommended for use.</p> <p>Note: This parameter field also controls the gating of 27-MHz clock source from DPLLA. When this clock is not being used, it is automatically gated off for power savings. When this parameter field is set to 000b, 27-MHz clock from DPLLA is enabled and not gated.</p> <p>Note: These clock select settings only take effect when this muxed FLEXCLK/GPIO pin is configured for FLEXCLK native usage. Refer to the <i>Intel® 7 Series / 216 Chipset FamilyEDS</i> for configuration of GPIO vs. native usage.</p>

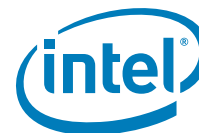

B.3.4 PLLRCS – PLL Reference Clock Select

Address Offset: 0x03h

Flash Image Tool/ME FW Default for FCIM: 0008_8CBFh

Recommended Overclocking Default for FCIM: 000A_8CBEh

FCIM HW Default: 0008_8CBDh

Description: This parameter controls clock source selection for PCI Express* clocks.

Flash Image Tool Configuration: Available in **ME Region | Configuration | ICC Data | ICC Profile 0 | FCIM/BTM Specific Registers**

Table B-6. PLL Reference Clock Select Parameters

Bits	Default	Description
31:20	0h	Reserved (RSVD)
19	1b	Chipset Configuration (PCHCFG): As specified by clock mode.
18:17	<p>FCIM 00b</p> <p>FCIM Overclocking 01b</p>	<p>SSCn Source Select for PXP PLL (SSCnSSPXPPLL): Selects the SSC source for use by PXP PLL.</p> <ul style="list-style-type: none"> In non-overclocking configurations, PXP PLL is expected to directly supply CLKOUT_DMI, CLKOUT_PEG[B:A], CLKOUT_ITPXDP, CLKOUT_SRC[7:0], and SATA, and indirectly supply CLKOUT_PCI[4:0] and CLKOUTFLEX[3:0] In overclocking configurations, PXP PLL is expected to directly supply CLKOUT_SRC[7:0], and SATA, and indirectly supply CLKOUT_PCI[4:0] and CLKOUTFLEX[3:0]. DMI PLL is expected to supply CLKOUT_DMI, CLKOUT_PEG[B:A], CLKOUT_ITPXDP. <p>FCIM 00b = SSC2 all other values = Reserved</p> <p>FCIM Overclocking 01b = SSC3 all other values = Reserved</p> <p>Note: FCIM overclocking requires a parameter value different from FCIM ME FW defaults. Note: Spread spectrum can be turned on and off for SSC[3:2] using “SSC[3:2] Enable, Active Low” parameters at SSCCTL[16,8] (see Section B.3.15)</p>
16:2	232Fh	Chipset Configuration (PCHCFG): As specified by clock mode.
1:0	<p>FCIM 11b</p> <p>FCIM Overclocking 10b</p>	<p>SATA PLL Reference Select (SATARS): Selects the SSC/input pin source for use by SATA PLL.</p> <p>FCIM 11b = SSC2 all other values = Reserved</p> <p>FCIM Overclocking 10b = SSC3 all other values = Reserved</p> <p>Note: FCIM overclocking requires a parameter value different from FCIM ME FW defaults. Note: Spread spectrum can be turned on and off for SSC[3:2] using “SSC[3:2] Enable, Active Low” parameters at SSCCTL[16,8] (see Section B.3.15).</p>



B.3.5 DPLLAC – Display PLL “A” Configuration

Note: This parameter is not available in the Flash Image Tool GUI. If editing access to this parameter is required, consult *Release Notes* released with this Intel® ME FW kit for instructions.

B.3.6 DPLLBC – Display PLL “B” Configuration

Note: This parameter is not available in the Flash Image Tool GUI. If editing access to this parameter is required, consult *Release Notes* released with this Intel® ME FW kit for instructions.

B.3.7 PLEN – PLL Enable

Address Offset: 0x0Ch

Flash Image Tool/ME FW Default for FCIM: 8000 000Ch
FCIM Default: 80000404h (before PCH_PWROK), 8000040Ch (after PCH_PWROK)

Description: This parameter controls PLL enables.
Flash Image Tool Configuration: Available in **ME Region | Configuration | ICC Data | ICC Profile 0 | FCIM/BTM Specific Registers**

Table B-7. PLL Enable Parameters

Bits	Default	Description
31	0b	Chipset Strap (PCHHWSTRP): Always reported as 1b .
30:11	0h	Reserved (RSVD)
10	HW: 1b FITC: 0b MEFW: 0b	SSC4 Ownership (SSC4OWN): Controls the owner of SSC4 and DIV4 (see Figure B-1). 0b = Display Driver controls SSC4-associated resources. 1b = ME controls SSC4-associated resources
9	0b	DPLLA/DPLLB/SSC1 Ownership (DPLLSSC1OWN): Controls the owner of DPLLA, DPLLB, and SSC1. 0b = Display Driver register set controls DPLLA, DPLLB, and SSC1 1b = ME FW controls DPLLA, DPLLB, and SSC1. This option must be selected if 27-MHz output is required from CLKOUTFLEX[3:0].
8:4	0h	Reserved (RSVD)
3:0	Ch	Chipset Configuration (PCHCFG): Must be set to Ch .

B.3.8 OCKEN – Output Clock Enable

Address Offset: 0x0Eh

Flash Image Tool/ME FW Default: No changes from HW defaults
HW Default: 1FFF_0F8Fh

Description: This parameter controls enabling of output buffers.
Flash Image Tool Configuration: Available in **ME Region | Configuration | ICC Data | ICC Profile 0 | ICC Registers**

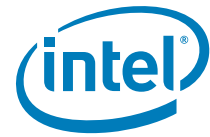

Table B-8. Output Clock Enable Parameters

Bits	Default	Description
31:29	0h	Reserved (RSVD)
28	1b	Chipset Configuration (PCHCFG): Must be set to 1b .
27	1b	PEG_B Output Clock Enable (PBOCKEN): Controls the enabling of PEG_B clock toggling. When this clock output is not used, it should be gated to low state to save power. 0b = Output clock is gated to low state 1b = Output buffer is enabled to toggle once its clock source has been initialized
26	1b	PEG_A Output Clock Enable (PAOCKEN): Controls the enabling of PEG_A clock toggling. When this clock output is not used, it should be gated to low state to save power. 0b = Output clock is gated to low state 1b = Output buffer is enabled to toggle once its clock source has been initialized
25	1b	DP120 Output Clock Enable (DPOCKEN): Controls the enabling of CLKOUT_DP clock toggling. When this clock output is not used, it should be gated to low state to save power. 0b = Output clock is gated to low state 1b = Output buffer is enabled to toggle once its clock source has been initialized Note: By default, the ownership of this bit is under display control. The display logic side (not ME FW) determines whether the output clock pin CLKOUT_DP toggles or gated to low state. Use the default value '1' for this bit.
24	1b	ITPXD Output Clock Enable (ITPXDPOCKEN): Controls the enabling of CLKOUT_ITPXD clock toggling. When this clock output is not used, it should be gated to low state to save power. 0b = Output clock is gated to low state 1b = Output clock is enabled to toggle once its clock source has been initialized
23:16	FFh	SRC 7:0 Output Clock Enable (SRC7OOCKEN): Controls the enabling of SRC clock toggling. Each bit position controls the corresponding SRC output clock, e.g. bit 0 controls SRC0. When any clock output is not used, it should be gated to low state to save power. 0b = Corresponding output clock is gated to low state 1b = Corresponding output clock is enabled to toggle once its clock source has been initialized (hot plug capable)
15:12	0h	Reserved (RSVD)
11:7	1Fh	PCICLK 4:0 Output Clock Enable (PCI4OOCKEN): Controls the enabling of PCI clock toggling. Each bit position controls the corresponding PCI output clock, e.g. bit 7 controls CLKOUT_PCI0. When any clock output is not used, it should be gated to low state to save power. 0b = Corresponding output clock is gated to low state 1b = Corresponding output clock is enabled to toggle once its clock source has been initialized A-stepping Note: This parameter has no effect and clock output is always enabled. B-stepping Note: Parameter behaves normally.
6:4	0h	Reserved (RSVD)
3:0	Fh	FLEXCLK 3:0 Output Clock Enable (FLEX3OOCKEN): Controls the enabling of FLEXCLK toggling. Each bit position controls the corresponding FLEXCLK output clock, e.g. LSB (bit 0) controls CLKOUTFLEX0. When any clock output is not used, it should be gated to low state to save power. 0b = Corresponding output clock is gated to low state 1b = Corresponding output clock is enabled to toggle once its clock source has been initialized



B.3.9 IBEN – Input Buffer Enable

Address Offset: 0x0Fh

Flash Image Tool/ME FW Default for FCIM: No changes from HW defaults

FCIM Default: 0000_002Fh

Description: This parameter controls enabling of input buffers.

Flash Image Tool Configuration: Available in ME Region | Configuration | ICC Data | ICC Profile 0 | FCIM/BTM Specific Registers

Table B-9. Input Buffer Enable Parameters

Bits	Default	Description
31:6	0h	Reserved (RSVD)
5:4	10b	<p>CLKIN_SATA Input Buffer Disable (CKINSATAInBufDis): Controls the differential input buffer for CLKIN_SATA. When CLKIN_SATA is not used, its input buffer should be turned off for power saving.</p> <p>00b = CLKIN_SATA Differential Input Buffer is subjected to dynamic power management control by the SATA logic as part of the SATACLKREQ# protocol to the external clock generator. This setting is only applicable when CLKIN_SATA is configured to only source PCH SATA PLL but not source any other clock consumers.</p> <p>01b = Input buffer is enabled</p> <p>1xb = Input buffer is disabled for power saving</p>
3	1b	Chipset Configuration (PCHCFG): Must be set to 1b .
2	1b	<p>CLKIN_DMI Input Buffer Disable (CKINDMIInBufDis): Controls the differential input buffer for CLKIN_DMI. When CLKIN_DMI is not used, its input buffer should be turned off for power saving.</p> <p>0b = Input buffer is enabled</p> <p>1b = Input buffer is disabled for power saving</p>
1	1b	<p>CLKIN_DOT96 Input Buffer Disable (CKIN96InBufDis): Controls the differential input buffer for CLKIN_DOT96. When CLKIN_DOT96 is not used, its input buffer should be turned off for power saving.</p> <p>0b = Input buffer is enabled</p> <p>1b = Input buffer is disabled for power saving</p>
0	1b	Chipset Configuration (PCHCFG): Set to 0b by hardware default (in BTM only), but required to be 1b .



B.3.10 DIVEN – Divider Enable

Address Offset: 0x10h

Flash Image Tool/ME FW Default for FCIM: 0000_05EBh

FCIM Default: 00000DFFh

Description: This parameter controls enabling of divider blocks.

Flash Image Tool Configuration: Available in **ME Region | Configuration | ICC Data | ICC Profile 0 | FCIM/BTM Specific Registers**

Table B-10. Divider Enable Parameters

Bits	Default	Description
31:12	0h	Reserved (RSVD)
11	HW: 1b ME FW: 0b FITC: 0b	Chipset Configuration (PCHCFG): Set to 1b by hardware default, but required to be 0b (in FCIM only).
10	1b	14.31818Mhz Fractional Divisor Enable (14FDEN): Enables fractional divisor for 14.31818Mhz clock generation (see Figure B-1). When not used, the fractional divisor can be disabled for power saving. 0b = Divider is disabled 1b = Divider is enabled Note: PCH use the 14.31818Mhz Fraction divisor to provide clock for PCH internal legacy 8254, and PM timers. Turning off the 14.31818Mhz Fraction divisor will turn off clock to the PCH legacy 8254, and PM timers. The 14.31818Mhz Fraction divisor should NOT be turn off even if it is not used externally .
9	0b	Reserved (RSVD)
8	1b	DIV7 Enable (DIV7EN): Enables DIV7 clock divider (see Figure B-1). 0b = Divider is enabled (120 Mhz generated from USB PLL) 1b = Divider is disabled (120Mhz generated by XCK PLL)
7	1b	DIV5 Stage 2 Enable (DIV5BEN): Enables DIV5B clock divider (see Figure B-1). 0b = Divider is disabled 1b = Divider is enabled
6	1b	DIV5 Stage 1 Enable (DIV5AEN): Enables DIV5A clock divider (see Figure B-1). 0b = Divider is disabled 1b = Divider is enabled
5	1b	DIV4 Enable (DIV4EN): Enables DIV4 clock divider (see Figure B-1). 0b = Divider is disabled 1b = Divider is enabled
4	HW: 1b ME FW: 0b FITC: 0b	DIV3 Enable (DIV3EN): Enables DIV3 clock divider (see Figure B-1). 0b = Divider is disabled 1b = Divider is enabled
3	1b	DIV2-S Enable (DIV2SEN): Enables DIV2-S clock divider (see Figure B-1). 0b = Divider is disabled 1b = Divider is enabled
2	HW: 1b ME FW: 0b FITC: 0b	DIV2-NS Enable (DIV2NSEN): Enables DIV2-NS clock divider (see Figure B-1). 0b = Divider is disabled 1b = Divider is enabled
1	1b	DIV1-S Enable (DIV1SEN): Enables DIV1-S clock divider (see Figure B-1). 0b = Divider is disabled 1b = Divider is enabled
0	1b	DIV1-NS Enable (DIV1NSEN): Enables DIV1-NS clock divider (see Figure B-1). 0b = Divider is disabled 1b = Divider is enabled



B.3.11 PM1 – Power Management

Address Offset: 0x12h

Flash Image Tool/ME FW Default: 0000_001Fh

HW Default: 0000_0000h

Description: This parameter controls power management features of clocks.

Flash Image Tool Configuration: Available in **ME Region | Configuration | ICC Data | ICC Profile 0 | ICC Registers**

Table B-11. Power Management Parameters

Bits	Default	Description
31:5	0h	Reserved (RSVD)
4	HW: 0b ME FW: 1b FITC: 1b	<p>Dynamic SSC1 Shutdown Enable (SSC1DSEN): Enables dynamic power management of DIV1-S (see Figure B-1, page 61).</p> <ul style="list-style-type: none"> Integrated Graphics Device Display Driver may dynamically power manage SSC1 when: <ul style="list-style-type: none"> Integrated Graphics Device Display Driver is assigned ownership of SSC1 (“DPLLA/DPLLB/SSC1 Ownership” parameter field at PLEN[9] = 0b, see Section B.3.5) SSC1 is globally enabled (“SSC1 Enable, Active Low” parameter field at SSCCTL[0] = 0b) This bit has no effect, (dynamic power management of DIV4 can only be performed through Intel® MEI message SET_ICC_REGISTER from BIOS during POST and S3 resume, not by Integrated Graphics Device Display Driver), when: <ul style="list-style-type: none"> ME is assigned ownership (PLEN[9] = 1b, see Section B.3.5). <p>The following are logical combinations of this parameter field (MSB) and “Dynamic DIV1S Shutdown Enable” parameter at PM1[0] (LSB). 00b = Disable dynamic management of DIV1-S and SSC1 01b = Dynamic management of DIV1-S only. SSC1 stays up and maintains current state for lower clock recovery latency at the expense of power. 10b = Reserved 11b = Dynamic management of both DIV1-S and SSC1. Longer clock recovery latency but more power savings.</p>
3:2	HW: 00b ME FW: 11b FITC: 11b	<p>Dynamic SSC4 and DIV4 Shutdown Enable (SSC4DIV4DSEN): Enables dynamic power management of SSC4 and DIV4 (see Figure B-1, page 61).</p> <ul style="list-style-type: none"> Integrated Graphics Device Display Driver may dynamically power manage SSC4 when: <ul style="list-style-type: none"> Integrated Graphics Device Display Driver is assigned ownership of SSC4 (“SSC4 Ownership” parameter at PLEN[10] = 0b, see Section B.3.5) SSC4 is globally enabled (“SSC4 Enable, Active Low” parameter field at SSCCTL[24] = 0b, see Section B.3.5) This bit has no effect, (dynamic power management of DIV4 can only be performed through Intel® MEI message SET_ICC_REGISTER from BIOS during POST and S3 resume, not by Integrated Graphics Device Display Driver), when: <ul style="list-style-type: none"> ME is assigned ownership (PLEN[10] = 1b, see Section B.3.5) <p>00b = Disable dynamic management of DIV4 and SSC4 01b = Dynamic management of DIV4 only. SSC4 stays up and maintains current state for lower clock recovery latency at the expense of power. 10b = Reserved 11b = Dynamic management of both DIV4 and SSC4. Longer clock recovery latency but more power savings.</p>
1	HW: 0b ME FW: 1b FITC: 1b	<p>Dynamic DIV1-NS Shutdown Enable (DIV1NSDSEN): Enables dynamic power management of DIV1-NS (see Figure B-1).</p> <p>0b = Disable dynamic power management of DIV1-S 1b = Enable dynamic power management of DIV1-S</p>
0	HW: 0b ME FW: 1b FITC: 1b	<p>Dynamic DIV1-S Shutdown Enable (DIV1SDSEN): Enables dynamic power management of DIV1-S (see Figure B-1).</p> <p>Note: Do not configure this parameter field on its own. See “DIV1 Shutdown Enable” parameter at PM1[4].</p>

B.3.12 PM2 – Power Management

Address Offset: 0x13h



Flash Image Tool/ME FW Default: No changes from HW defaults
HW Default: 0000_0000h

Description: This parameter controls power management features of clocks.
Flash Image Tool Configuration: Available in **ME Region | Configuration | ICC Data | ICC Profile 0 | ICC Registers**

Table B-12. Power Management Parameters

Bits	Default	Description
31:9	0h	Reserved (RSVD)
8:5	0000b	CLKRUN Control Enable for PCI 33 Mhz on CLKOUTFLEX (CLKRUNCEN_FLEX): Enables support for CLKRUN protocol for PCI 33 MHz clocks muxed out to CLKOUTFLEX[3:0]. 0b = Corresponding CLKOUTFLEX PCI clock is free-running, unaffected by CLKRUN protocol 1b = Corresponding CLKOUTFLEX PCI clock is shut off when CLKRUN protocol turns off PCI clocks Note: These bits must be clear (0b) when the corresponding CLKOUTFLEX pins are not configured for PCI 33Mhz clock.
4:0	0 0000b	CLKRUN Control Enable (CLKRUNCEN): Enables support for CLKRUN protocol for CLKOUT_PCI[4:0]. 0b = Corresponding CLKOUT_PCI is free-running, unaffected by CLKRUN protocol 1b = Corresponding CLKOUT_PCI is shut off when CLKRUN protocol turns off PCI clocks Note: This parameter does not enable CLKRUN protocol support for CLKOUTFLEX[3:0].

B.3.13 SEBP1 – Single Ended Buffer Parameters

Address Offset: 0x1Ch

Flash Image Tool/ME FW Default: No changes from HW defaults
HW Default: 0000_9999h

Description: This parameter controls double/single load series resistance and slew rate for FLEX clocks.

Flash Image Tool Configuration: Not present in Flash Image Tool

Table B-13. Single Ended Buffer Parameters (Sheet 1 of 2)

Bits	Default	Description
31:16	0h	Reserved (RSVD)
15:13	100b	FLEXCLK3 Slew Rate Control (F3SLC): Controls slew rate for CLKOUTFLEX3. 000b = Weakest slew rate setting (~0.6 V/ns for a TBD inch trace at double load) 001b 010b 011b 100b = Default Slew rate setting (~1.4V/ns for a TBD inch trace at double load) 101b 110b 111b = Strongest slew rate setting (~2 V/ns for a TBD inch trace at double load)
12	1b	FLEXCLK3 Single/Double Load Series Resistance (F3SDLSR): Sets programmable series resistance for CLKOUTFLEX3. 0b = 25 Ohms for single load usage 1b = 17 Ohms for double load usage

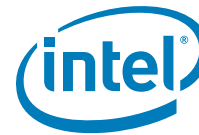

Table B-13. Single Ended Buffer Parameters (Sheet 2 of 2)

Bits	Default	Description
11:9	100b	FLEXCLK2 Slew Rate Control (F2SLC): Controls slew rate for CLKOUTFLEX2. 000b = Weakest slew rate setting (~0.6 V/ns for a TBD inch trace at double load) 001b 010b 011b 100b = Default Slew rate setting (~1.4V/ns for a TBD inch trace at double load) 101b 110b 111b = Strongest slew rate setting (~2 V/ns for a TBD inch trace at double load)
8	1b	FLEXCLK2 Single/Double Load Series Resistance (F2SDLSR): Sets programmable series resistance for CLKOUTFLEX2. 0b = 25 Ohms for single load usage 1b = 17 Ohms for double load usage
7:5	100b	FLEXCLK1 Slew Rate Control (F1SLC): Controls slew rate for CLKOUTFLEX1. 000b = Weakest slew rate setting (~0.6 V/ns for a TBD inch trace at double load) 001b 010b 011b 100b = Default Slew rate setting (~1.4V/ns for a TBD inch trace at double load) 101b 110b 111b = Strongest slew rate setting (~2 V/ns for a TBD inch trace at double load)
4	1b	FLEXCLK1 Single/Double Load Series Resistance (F1SDLSR): Sets programmable series resistance for CLKOUTFLEX1. 0b = 25 Ohms for single load usage 1b = 17 Ohms for double load usage
3:1	100b	FLEXCLK0 Slew Rate Control (F2SLC): Controls slew rate for CLKOUTFLEX2. 000b = Weakest slew rate setting (~0.6 V/ns for a TBD inch trace at double load) 001b 010b 011b 100b = Default Slew rate setting (~1.4V/ns for a TBD inch trace at double load) 101b 110b 111b = Strongest slew rate setting (~2 V/ns for a TBD inch trace at double load)
0	1b	FLEXCLK0 Single/Double Load Series Resistance (F0SDLSR): Sets programmable series resistance for CLKOUTFLEX0. 0b = 25 Ohms for single load usage 1b = 17 Ohms for double load usage

B.3.14 SEBP2 – Single Ended Buffer Parameters

Address Offset: 0x1Dh

Flash Image Tool/ME FW Default: No changes from HW defaults

HW Default: 0009_9999h

Description: This parameter controls double/single load series resistance and slew rate for PCI clocks. PCI Specifications 2.4 and 3.0 allow for an acceptable slew rate range of 1 to 4 V/ns. ME FW programmability allows for slew rate to be specified between 0.6 to 2 V/ns for two reasons:

1. Slew rates exceeding 2 V/ns can have adverse effects on platform EMI
2. Slew rates lower than 1 V/ns can be specified for EMI benefits, at the risk of violating PCI specification

Flash Image Tool Configuration: Available in **ME Region | Configuration | ICC Data | ICC Profile 0 | ICC Registers**



Table B-14. Single Ended Buffer Parameters (Sheet 1 of 2)

Bits	Default	Description
31:20	0h	Reserved (RSVD)
19:17	100b	PCI4 Slew Rate Control (PCI4SLC): Controls slew rate for CLKOUTPCI4. 000b = Weakest slew rate setting (~0.6 V/ns for a TBD inch trace at double load) 001b 010b 011b 100b = Default Slew rate setting (~1.4V/ns for a TBD inch trace at double load) 101b 110b 111b = Strongest slew rate setting (~2 V/ns for a TBD inch trace at double load)
16	1b	PCI4 Single/Double Load Series Resistance (PCI4SDLR): Sets programmable series resistance for CLKOUT_PCI4. 0b = 25 Ohms for single load usage 1b = 17 Ohms for double load usage
15:13	100b	PCI3 Slew Rate Control (PCI3SLC): Controls slew rate for CLKOUT_PCI3. 000b = Weakest slew rate setting (~0.6 V/ns for a TBD inch trace at double load) 001b 010b 011b 100b = Default Slew rate setting (~1.4V/ns for a TBD inch trace at double load) 101b 110b 111b = Strongest slew rate setting (~2 V/ns for a TBD inch trace at double load)
12	1b	PCI3 Single/Double Load Series Resistance (PCI3SDLR): Sets programmable series resistance for CLKOUT_PCI3. 0b = 25 Ohms for single load usage 1b = 17 Ohms for double load usage
11:9	100b	PCI2 Slew Rate Control (PCI2SLC): Controls slew rate for CLKOUT_PCI2. 000b = Weakest slew rate setting (~0.6 V/ns for a TBD inch trace at double load) 001b 010b 011b 100b = Default Slew rate setting (~1.4V/ns for a TBD inch trace at double load) 101b 110b 111b = Strongest slew rate setting (~2 V/ns for a TBD inch trace at double load)
8	1b	PCI2 Single/Double Load Series Resistance (PCI2SDLR): Sets programmable series resistance for CLKOUT_PCI2. 0b = 25 Ohms for single load usage 1b = 17 Ohms for double load usage
7:5	100b	PCI1 Slew Rate Control (PCI1SLC): Controls slew rate for CLKOUT_PCI1. 000b = Weakest slew rate setting (~0.6 V/ns for a TBD inch trace at double load) 001b 010b 011b 100b = Default Slew rate setting (~1.4V/ns for a TBD inch trace at double load) 101b 110b 111b = Strongest slew rate setting (~2 V/ns for a TBD inch trace at double load)



Table B-14. Single Ended Buffer Parameters (Sheet 2 of 2)

Bits	Default	Description
4	1b	PCI 1 Single/Double Load Series Resistance (PCI1SDLR) : Sets programmable series resistance for CLKOUT_PCI1. 0b = 25 Ohms for single load usage 1b = 17 Ohms for double load usage
3:1	100b	PCI0 Slew Rate Control (PCI0SLC) : Controls slew rate for CLKOUT_PCI0. 000b = Weakest slew rate setting (~0.6 V/ns for a TBD inch trace at double load) 001b 010b 011b 100b = Default Slew rate setting (~1.4V/ns for a TBD inch trace at double load) 101b 110b 111b = Strongest slew rate setting (~2 V/ns for a TBD inch trace at double load)
0	1b	PCI0 Single/Double Load Series Resistance (PCI0SDLR) : Sets programmable series resistance for CLKOUT_PCI0. 0b = 25 Ohms for single load usage 1b = 17 Ohms for double load usage

B.3.15 SSCCTL – SSC Control

Address Offset: 0x24h

Flash Image Tool/ME FW Default for FCIM: 0001_0000h

FCIM Default: 0000_0000h

Description: This parameter controls spread spectrum modulation capability of SSC blocks.

Flash Image Tool Configuration: Available in **ME Region | Configuration | ICC Data | ICC Profile 0 | FCIM/BTM Specific Registers**

Table B-15. SSC Control Parameters (Sheet 1 of 2)

Bits	Default	Description
31:27	0h	Reserved (RSVD)
26:25	00b	SSC4 Spread Mode (SSC4_SprMd) : Select the spread mode for SSC4. 00b = Down spread 01b = Center spread 10b = Reserved 11b = Reserved
24	0b	SSC4 Enable, Active Low (SSC4_EnB) : Determines whether SSC4 (see Figure B-1 , page 61) is enabled. 0b = Enable SSC4 1b = Power off SSC4 and select bypass path to SSC4 output. SSC4 output will thus be non-spread.
23:19	0h	Reserved (RSVD)
18:17	00b	SSC3 Spread Mode (SSC3_SprMd) : Select the spread mode for SSC3. 00b = Down spread 01b = Center spread 10b = Reserved 11b = Reserved
16	0b	SSC3 Enable, Active Low (SSC3_EnB) : Determines whether SSC3 (see Figure B-1 , page 61) is enabled. 0b = Enable SSC3 1b = Power off SSC3 and select bypass path to SSC3 output. SSC3 output will thus be non-spread.
15:11	0h	Reserved (RSVD)



Table B-15. SSC Control Parameters (Sheet 2 of 2)

Bits	Default	Description
10:9	00b	SSC2 Spread Mode (SSC2_SprdMd) : Select the spread mode for SSC2. 00b = Down spread 01b = Center spread 10b = Reserved 11b = Reserved
8	0b	SSC2 Enable, Active Low (SSC2_EnB) : Determines whether SSC2 (see Figure B-1 , page 61) is enabled. 0b = Enable SSC2 1b = Power off SSC2 and select bypass path to SSC2 output. SSC2 output will thus be non-spread.
7:3	0h	Reserved (RSVD)
2:1	00b	SSC1 Spread Mode (SSC1_SprdMd) : Select the spread mode for SSC1. 00b = Down spread 01b = Center spread 10b = Reserved 11b = Reserved
0	0b	SSC1 Enable, Active Low (SSC1_EnB) : Determines whether SSC1 (see Figure B-1 , page 61) is enabled. 0b = Enable SSC1 1b = Power off SSC1 and select bypass path to SSC1 output. SSC1 output will thus be non-spread.

B.3.16 PMSRCCLK1 – SRC Power Management

Address Offset: 0x48h

Flash Image Tool/ME FW Default: No changes from HW defaults

HW Default: 7654_3210h

Description: This parameter as signs dynamic CLKRQ# control of SRC clocks.

Flash Image Tool Configuration: Available in [ME Region](#) | [Configuration](#) | [ICC Data](#) | [ICC Profile 0](#) | [ICC Registers](#)



Table B-16. SRC Power Management (Sheet 1 of 2)

Bits	Default	Description
31:28	0111b	<p>CLKRQ# Select for CLKOUT_SRC7 (CRQSELSRC7): Select external input CLKRQ# pin for dynamic control of CLKOUT_SRC7 output.</p> <p> 0000b = SRC0CLKRQ#/GPIO73 controls CLKOUT_SRC7 0001b = SRC1CLKRQ#/GPIO18 controls CLKOUT_SRC7 0010b = SRC2CLKRQ#/GPIO20 controls CLKOUT_SRC7 0011b = SRC3CLKRQ#/GPIO25 controls CLKOUT_SRC7 0100b = SRC4CLKRQ#/GPIO26 controls CLKOUT_SRC7 0101b = SRC5CLKRQ#/GPIO44 controls CLKOUT_SRC7 0110b = SRC6CLKRQ#/GPIO45 controls CLKOUT_SRC7 0111b = SRC7CLKRQ#/GPIO46 controls CLKOUT_SRC7 1000b = SRC8CLKRQ#/PEG_A_CLKRQ#/GPIO47 controls CLKOUT_SRC7 1001b = SRC9CLKRQ#/PEG_B_CLKRQ#/GPIO56 controls CLKOUT_SRC7 1x1xb = Reserved </p>
27:24	0110b	<p>CLKRQ# Select for CLKOUT_SRC6 (CRQSELSRC6): Select external input CLKRQ# pin for dynamic control of CLKOUT_SRC6 output.</p> <p> 0000b = SRC0CLKRQ#/GPIO73 controls CLKOUT_SRC6 0001b = SRC1CLKRQ#/GPIO18 controls CLKOUT_SRC6 0010b = SRC2CLKRQ#/GPIO20 controls CLKOUT_SRC6 0011b = SRC3CLKRQ#/GPIO25 controls CLKOUT_SRC6 0100b = SRC4CLKRQ#/GPIO26 controls CLKOUT_SRC6 0101b = SRC5CLKRQ#/GPIO44 controls CLKOUT_SRC6 0110b = SRC6CLKRQ#/GPIO45 controls CLKOUT_SRC6 0111b = SRC7CLKRQ#/GPIO46 controls CLKOUT_SRC6 1000b = SRC8CLKRQ#/PEG_A_CLKRQ#/GPIO47 controls CLKOUT_SRC6 1001b = SRC9CLKRQ#/PEG_B_CLKRQ#/GPIO56 controls CLKOUT_SRC6 1x1xb = Reserved </p>
23:20	0101b	<p>CLKRQ# Select for CLKOUT_SRC5 (CRQSELSRC5): Select external input CLKRQ# pin for dynamic control of CLKOUT_SRC5 output.</p> <p> 0000b = SRC0CLKRQ#/GPIO73 controls CLKOUT_SRC5 0001b = SRC1CLKRQ#/GPIO18 controls CLKOUT_SRC5 0010b = SRC2CLKRQ#/GPIO20 controls CLKOUT_SRC5 0011b = SRC3CLKRQ#/GPIO25 controls CLKOUT_SRC5 0100b = SRC4CLKRQ#/GPIO26 controls CLKOUT_SRC5 0101b = SRC5CLKRQ#/GPIO44 controls CLKOUT_SRC5 0110b = SRC6CLKRQ#/GPIO45 controls CLKOUT_SRC5 0111b = SRC7CLKRQ#/GPIO46 controls CLKOUT_SRC5 1000b = SRC8CLKRQ#/PEG_A_CLKRQ#/GPIO47 controls CLKOUT_SRC5 1001b = SRC9CLKRQ#/PEG_B_CLKRQ#/GPIO56 controls CLKOUT_SRC5 1x1xb = Reserved </p>
19:16	0100b	<p>CLKRQ# Select for CLKOUT_SRC4 (CRQSELSRC4): Select external input CLKRQ# pin for dynamic control of CLKOUT_SRC4 output.</p> <p> 0000b = SRC0CLKRQ#/GPIO73 controls CLKOUT_SRC4 0001b = SRC1CLKRQ#/GPIO18 controls CLKOUT_SRC4 0010b = SRC2CLKRQ#/GPIO20 controls CLKOUT_SRC4 0011b = SRC3CLKRQ#/GPIO25 controls CLKOUT_SRC4 0100b = SRC4CLKRQ#/GPIO26 controls CLKOUT_SRC4 0101b = SRC5CLKRQ#/GPIO44 controls CLKOUT_SRC4 0110b = SRC6CLKRQ#/GPIO45 controls CLKOUT_SRC4 0111b = SRC7CLKRQ#/GPIO46 controls CLKOUT_SRC4 1000b = SRC8CLKRQ#/PEG_A_CLKRQ#/GPIO47 controls CLKOUT_SRC4 1001b = SRC9CLKRQ#/PEG_B_CLKRQ#/GPIO56 controls CLKOUT_SRC4 1x1xb = Reserved </p>
15:12	0011b	<p>CLKRQ# Select for CLKOUT_SRC3 (CRQSELSRC3): Select external input CLKRQ# pin for dynamic control of CLKOUT_SRC3 output.</p> <p> 0000b = SRC0CLKRQ#/GPIO73 controls CLKOUT_SRC3 0001b = SRC1CLKRQ#/GPIO18 controls CLKOUT_SRC3 0010b = SRC2CLKRQ#/GPIO20 controls CLKOUT_SRC3 0011b = SRC3CLKRQ#/GPIO25 controls CLKOUT_SRC3 0100b = SRC4CLKRQ#/GPIO26 controls CLKOUT_SRC3 0101b = SRC5CLKRQ#/GPIO44 controls CLKOUT_SRC3 0110b = SRC6CLKRQ#/GPIO45 controls CLKOUT_SRC3 0111b = SRC7CLKRQ#/GPIO46 controls CLKOUT_SRC3 1000b = SRC8CLKRQ#/PEG_A_CLKRQ#/GPIO47 controls CLKOUT_SRC3 1001b = SRC9CLKRQ#/PEG_B_CLKRQ#/GPIO56 controls CLKOUT_SRC3 1x1xb = Reserved </p>



Table B-16. SRC Power Management (Sheet 2 of 2)

Bits	Default	Description
11:8	0010b	<p>CLKRQ# Select for CLKOUT_SRC2 (CRQSELSRC2): Select external input CLKRQ# pin for dynamic control of CLKOUT_SRC2 output.</p> <p> 0000b = SRC0CLKRQ#/GPIO73 controls CLKOUT_SRC2 0001b = SRC1CLKRQ#/GPIO18 controls CLKOUT_SRC2 0010b = SRC2CLKRQ#/GPIO20 controls CLKOUT_SRC2 0011b = SRC3CLKRQ#/GPIO25 controls CLKOUT_SRC2 0100b = SRC4CLKRQ#/GPIO26 controls CLKOUT_SRC2 0101b = SRC5CLKRQ#/GPIO44 controls CLKOUT_SRC2 0110b = SRC6CLKRQ#/GPIO45 controls CLKOUT_SRC2 0111b = SRC7CLKRQ#/GPIO46 controls CLKOUT_SRC2 1000b = SRC8CLKRQ#/PEG_A_CLKRQ#/GPIO47 controls CLKOUT_SRC2 1001b = SRC9CLKRQ#/PEG_B_CLKRQ#/GPIO56 controls CLKOUT_SRC2 1x1xb = Reserved </p>
7:4	0001b	<p>CLKRQ# Select for CLKOUT_SRC1 (CRQSELSRC1): Select external input CLKRQ# pin for dynamic control of CLKOUT_SRC1 output.</p> <p> 0000b = SRC0CLKRQ#/GPIO73 controls CLKOUT_SRC1 0001b = SRC1CLKRQ#/GPIO18 controls CLKOUT_SRC1 0010b = SRC2CLKRQ#/GPIO20 controls CLKOUT_SRC1 0011b = SRC3CLKRQ#/GPIO25 controls CLKOUT_SRC1 0100b = SRC4CLKRQ#/GPIO26 controls CLKOUT_SRC1 0101b = SRC5CLKRQ#/GPIO44 controls CLKOUT_SRC1 0110b = SRC6CLKRQ#/GPIO45 controls CLKOUT_SRC1 0111b = SRC7CLKRQ#/GPIO46 controls CLKOUT_SRC1 1000b = SRC8CLKRQ#/PEG_A_CLKRQ#/GPIO47 controls CLKOUT_SRC1 1001b = SRC9CLKRQ#/PEG_B_CLKRQ#/GPIO56 controls CLKOUT_SRC1 1x1xb = Reserved </p>
3:0	0000b	<p>CLKRQ# Select for CLKOUT_SRC0 (CRQSELSRC0): Select external input CLKRQ# pin for dynamic control of CLKOUT_SRC0 output.</p> <p> 0000b = SRC0CLKRQ#/GPIO73 controls CLKOUT_SRC0 0001b = SRC1CLKRQ#/GPIO18 controls CLKOUT_SRC0 0010b = SRC2CLKRQ#/GPIO20 controls CLKOUT_SRC0 0011b = SRC3CLKRQ#/GPIO25 controls CLKOUT_SRC0 0100b = SRC4CLKRQ#/GPIO26 controls CLKOUT_SRC0 0101b = SRC5CLKRQ#/GPIO44 controls CLKOUT_SRC0 0110b = SRC6CLKRQ#/GPIO45 controls CLKOUT_SRC0 0111b = SRC7CLKRQ#/GPIO46 controls CLKOUT_SRC0 1000b = SRC8CLKRQ#/PEG_A_CLKRQ#/GPIO47 controls CLKOUT_SRC0 1001b = SRC9CLKRQ#/PEG_B_CLKRQ#/GPIO56 controls CLKOUT_SRC0 1x1xb = Reserved </p>

B.3.17 PMSRCCLK2 – SRC Power Management

Address Offset: 0x49h

Flash Image Tool/ME FW Default: No changes from HW defaults

HW Default: 0000_0F98h

Description: This parameter assigns dynamic CLKRQ# control of SRC clocks.

Flash Image Tool Configuration: Available in **ME Region | Configuration | ICC Data | ICC Profile 0 | ICC Registers**

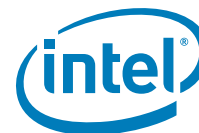

Table B-17. SRC Power Management

Bits	Default	Description
31:27	0h	Reserved (RSVD)
26	0b	CLKRQ# Control Enable for CLKOUT_ITPXDP: Enables support for CLKRQ# power management control for PCI Express* clock output to CLKOUT_ITPXDP. 0b = Disable dynamic control of CLKOUT_ITPXDP clock 1b = CLKOUT_ITPXDP clock is dynamically controlled by assigned CLKRQ# pin
25	0b	CLKRQ# Control Enable for CLKOUT_PEG_B: Enables support for CLKRQ# power management control for PCI Express* clock output to CLKOUT_PEG_B. 0b = Disable dynamic control of corresponding CLKOUT_SRC clock 1b = CLKOUT_PEG_B clock is dynamically controlled by assigned CLKRQ# pin
24	0b	CLKRQ# Control Enable for CLKOUT_PEG_A: Enables support for CLKRQ# power management control for PCI Express* clock output to CLKOUT_PEG_A. 0b = Disable dynamic control of corresponding CLKOUT_SRC clock 1b = CLKOUT_PEG_A clock is dynamically controlled by assigned CLKRQ# pin
23:16	0000 0000b	CLKRQ# Control Enable for CLKOUT_SRC[7:0]: Enables support for CLKRQ# power management control for PCI Express* clock outputs to CLKOUT_SRC[7:0]. 0b = Disable dynamic control of corresponding CLKOUT_SRC clock 1b = Corresponding CLKOUT_SRC clock is dynamically controlled by assigned CLKRQ# pin
15:12	0h	Reserved (RSVD)
11:8	1111b	CLKRQ# Select for CLKOUT_ITPXDP (CRQSELI TPXDP): Select external input CLKRQ# pin for dynamic control of CLKOUT_SRC7 output. 0000b = SRC0CLKRQ#/GPIO73 controls CLKOUT_ITPXDP 0001b = SRC1CLKRQ#/GPIO18 controls CLKOUT_ITPXDP 0010b = SRC2CLKRQ#/GPIO20 controls CLKOUT_ITPXDP 0011b = SRC3CLKRQ#/GPIO25 controls CLKOUT_ITPXDP 0100b = SRC4CLKRQ#/GPIO26 controls CLKOUT_ITPXDP 0101b = SRC5CLKRQ#/GPIO44 controls CLKOUT_ITPXDP 0110b = SRC6CLKRQ#/GPIO45 controls CLKOUT_ITPXDP 0111b = SRC7CLKRQ#/GPIO46 controls CLKOUT_ITPXDP 1000b = SRC8CLKRQ#/PEG_A_CLKRQ#/GPIO47 controls CLKOUT_ITPXDP 1001b = SRC9CLKRQ#/PEG_B_CLKRQ#/GPIO56 controls CLKOUT_ITPXDP 1x1xb = Reserved Note: The default value for this register is a reserved value. Change to assign CLKOUT_ITPXDP to a CLKRQ# pin, if CLKRQ# functionality is enabled (see "CLKRQ# Control Enable for CLKOUT_ITPXDP" parameter at PMSRCCLK2[26]).
7:4	1001b	CLKRQ# Select for CLKOUT_PEG_B (CRQSELPEGB): Select external input CLKRQ# pin for dynamic control of CLKOUT_PEG_B output. 0000b = SRC0CLKRQ#/GPIO73 controls CLKOUT_PEG_B 0001b = SRC1CLKRQ#/GPIO18 controls CLKOUT_PEG_B 0010b = SRC2CLKRQ#/GPIO20 controls CLKOUT_PEG_B 0011b = SRC3CLKRQ#/GPIO25 controls CLKOUT_PEG_B 0100b = SRC4CLKRQ#/GPIO26 controls CLKOUT_PEG_B 0101b = SRC5CLKRQ#/GPIO44 controls CLKOUT_PEG_B 0110b = SRC6CLKRQ#/GPIO45 controls CLKOUT_PEG_B 0111b = SRC7CLKRQ#/GPIO46 controls CLKOUT_PEG_B 1000b = SRC8CLKRQ#/PEG_A_CLKRQ#/GPIO47 controls CLKOUT_PEG_B 1001b = SRC9CLKRQ#/PEG_B_CLKRQ#/GPIO56 controls CLKOUT_PEG_B 1x1xb = Reserved
3:0	1000b	CLKRQ# Select for CLKOUT_PEG_A (CRQSELPEGA): Select external input CLKRQ# pin for dynamic control of CLKOUT_PEG_A output. 0000b = SRC0CLKRQ#/GPIO73 controls CLKOUT_PEG_A 0001b = SRC1CLKRQ#/GPIO18 controls CLKOUT_PEG_A 0010b = SRC2CLKRQ#/GPIO20 controls CLKOUT_PEG_A 0011b = SRC3CLKRQ#/GPIO25 controls CLKOUT_PEG_A 0100b = SRC4CLKRQ#/GPIO26 controls CLKOUT_PEG_A 0101b = SRC5CLKRQ#/GPIO44 controls CLKOUT_PEG_A 0110b = SRC6CLKRQ#/GPIO45 controls CLKOUT_PEG_A 0111b = SRC7CLKRQ#/GPIO46 controls CLKOUT_PEG_A 1000b = SRC8CLKRQ#/PEG_A_CLKRQ#/GPIO47 controls CLKOUT_PEG_A 1001b = SRC9CLKRQ#/PEG_B_CLKRQ#/GPIO56 controls CLKOUT_PEG_A 1x1xb = Reserved



B.3.18 PI 12BiasParms – Phase Interpolators 1 & 2 Biasing Parameters

Address Offset: 0x29h

Flash Image Tool/ME FW Default: No changes from HW defaults

HW Default: 0888_0888h

Recommended Overclocking Default for FCIM: 0000_0888h

Description: This parameter control Phase Interpolators 1 & 2 Biasing.

Flash Image Tool Configuration: Available in ME Region | Configuration | ICC Data | ICC Profile 0 | ICC Registers

Table B-18. Phase Interpolators 1 & 2 Biasing Parameters

Bits	Default	Description
31:0	0888_0888h	Chipset Configuration (PCHCFG): FCIM 0888_0888h FCIM Overclocking 0000_0888h

B.3.19 SSC2OCPARMS – SSC2 Overclock Parameters

Address Offset: 0x39h

Flash Image Tool/ME FW Default: No changes from HW defaults

HW Default: 0000_0000h

Description: This parameter control SSC2 Overclock Parameters.

Flash Image Tool Configuration: Available in ME Region | Configuration | ICC Data | ICC Profile 0 | ICC Registers

Table B-19. SSC2 Overclock Parameters

Bits	Default	Description
31:0	0000_0000h	Chipset Configuration (PCHCFG): Wimax Friendly clcoking 0000_0300h Other 0000_0000h

B.3.20 PCH Clock output / ICC registers mapping - part A

The following table map each one of the PCH outputs with the ICC registers bit that is configurable in the FITc tool (ICC profile).



Table B-20. PCH Clock output / ICC registers mapping - part A (Sheet 1 of 3)

ICC Registers	CLKOUT_DMI	CLKOUT_PEG (A)	CLKOUT_PEG (B)	CLKOUT_ITPXD	CLKOUT_SRC [7:0]
CSS	CSS[16:12] Chipset Configuration (PCHCFG)	CSS[16:12] Chipset Configuration (PCHCFG)	CSS[16:12] Chipset Configuration (PCHCFG)	CSS[16:12] Chipset Configuration (PCHCFG)	CSS[16:12] Chipset Configuration (PCHCFG)
				CSS[9:3] Chipset Configuration (PCHCFG)	
SSS	SSS[20] DMI Port Clock Select (DMIPORTCS)	SSS[20] DMI Port Clock Select (DMIPORTCS)	SSS[20] DMI Port Clock Select (DMIPORTCS)	SSS[20] DMI Port Clock Select (DMIPORTCS)	SSS[20] DMI Port Clock Select (DMIPORTCS)
					SSS[6:4] SRC[7:4] Clock Source Select (SRC3OCSS) (SSC2 or SSC3)
					SSS[2:0] SRC[3:0] Clock Source Select (SRC3OCSS) (SSC2 or SSC3)
FCSS	N/A	N/A	N/A	N/A	N/A
DPLLAC/B	N/A	N/A	N/A	N/A	N/A
PLLRCs	PLLRCs[18:17] SSCn Source Select for PXP PLL	PLLRCs[18:17] SSCn Source Select for PXP PLL	PLLRCs[18:17] SSCn Source Select for PXP PLL	PLLRCs[18:17] SSCn Source Select for PXP PLL	PLLRCs[19] Chipset Configuration (PCHCFG)
	PLLRCs[16:2] Chipset Configuration (PCHCFG)	PLLRCs[16:2] Chipset Configuration (PCHCFG)	PLLRCs[16:2] Chipset Configuration (PCHCFG)	PLLRCs[16:2] Chipset Configuration (PCHCFG)	PLLRCs[18:17] SSCn Source Select for PXP PLL
Pllen	Pllen[31] Chipset Strap (PCHHWSTRP) Note: this is a read only reg and cannot be set	Pllen[31] Chipset Strap (PCHHWSTRP) Note: this is a read only reg and cannot be set	Pllen[31] Chipset Strap (PCHHWSTRP) Note: this is a read only reg and cannot be set	Pllen[31] Chipset Strap (PCHHWSTRP) Note: this is a read only reg and cannot be set	Pllen[31] Chipset Strap (PCHHWSTRP) Note: this is a read only reg and cannot be set
	Pllen[3:0] Chipset Configuration (PCHCFG)	Pllen[3:0] Chipset Configuration (PCHCFG)	Pllen[3:0] Chipset Configuration (PCHCFG)	Pllen[3:0] Chipset Configuration (PCHCFG)	Pllen[3:0] Chipset Configuration (PCHCFG)
Ocken	Ocken[28] Chipset Configuration (PCHCFG)	Ocken[26] PEG_A Output Clock Enable (PAOCKEN)	Ocken[27] PEG_B Output Clock Enable (PBOCKEN)	Ocken[24] ITPXD Output Clock Enable (ITPXDPOCKEN)	Ocken[23:16] SRC 7:0 Output Clock Enable (SRC7OOCKEN)
IBEN	For FCIM configuration, use default values				

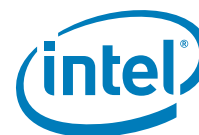

Table B-20. PCH Clock output / ICC registers mapping - part A (Sheet 2 of 3)

ICC Registers	CLKOUT_DMI	CLKOUT_PEG (A)	CLKOUT_PEG (B)	CLKOUT_ITPXD	CLKOUT_SRC [7:0]
DIVEN	DIVEN[4] DIV3 Enable (DIV3EN)	DIVEN[4] DIV3 Enable (DIV3EN)	DIVEN[4] DIV3 Enable (DIV3EN)	DIVEN[4] DIV3 Enable (DIV3EN)	DIVEN[4] DIV3 Enable (DIV3EN)
	DIVEN[3] DIV2-S Enable (DIV2SEN)	DIVEN[3] DIV2-S Enable (DIV2SEN)	DIVEN[3] DIV2-S Enable (DIV2SEN)	DIVEN[3] DIV2-S Enable (DIV2SEN)	DIVEN[3] DIV2-S Enable (DIV2SEN)
PM1	N/A	N/A	N/A	N/A	N/A
PM2	N/A	N/A	N/A	N/A	N/A
SEBP1	N/A	N/A	N/A	N/A	N/A
SEBP2	N/A	N/A	N/A	N/A	N/A
SSCCTL	SSCCTL[10:9] SSC2 Spread Mode (SSC2_SprdMd)	SSCCTL[10:9] SSC2 Spread Mode (SSC2_SprdMd)	SSCCTL[10:9] SSC2 Spread Mode (SSC2_SprdMd)	SSCCTL[10:9] SSC2 Spread Mode (SSC2_SprdMd)	SSCCTL[10:9] SSC2 Spread Mode (SSC2_SprdMd)
	SSCCTL[8] SSC2 Enable, Active Low (SSC2_EnB)	SSCCTL[8] SSC2 Enable, Active Low (SSC2_EnB)	SSCCTL[8] SSC2 Enable, Active Low (SSC2_EnB)	SSCCTL[8] SSC2 Enable, Active Low (SSC2_EnB)	SSCCTL[8] SSC2 Enable, Active Low (SSC2_EnB)
PMSRCCLK1	N/A	N/A	N/A	N/A	PMSRCCLK1[31:28] CLKRQ# Select for CLKOUT_SRC7 (CRQSELSRC7)
					PMSRCCLK1[27:24] CLKRQ# Select for CLKOUT_SRC6 (CRQSELSRC6)
					PMSRCCLK1[23:20] CLKRQ# Select for CLKOUT_SRC5 (CRQSELSRC5)
					PMSRCCLK1[19:16] CLKRQ# Select for CLKOUT_SRC4 (CRQSELSRC4)
					PMSRCCLK1[15:12] CLKRQ# Select for CLKOUT_SRC3 (CRQSELSRC3)
					PMSRCCLK1[11:8] CLKRQ# Select for CLKOUT_SRC2 (CRQSELSRC2)
					PMSRCCLK1[7:4] CLKRQ# Select for CLKOUT_SRC1 (CRQSELSRC1)
					PMSRCCLK1[3:0] CLKRQ# Select for CLKOUT_SRC0 (CRQSELSRC0)



Table B-20. PCH Clock output / ICC registers mapping - part A (Sheet 3 of 3)

ICC Registers	CLKOUT_DMI	CLKOUT_PEG (A)	CLKOUT_PEG (B)	CLKOUT_ITPXDP	CLKOUT_SRC [7:0]
PMSRCCLK2	N/A	PMSRCCLK2[24] CLKRQ# Control Enable for CLKOUT_PEG_A:	PMSRCCLK2[25] CLKRQ# Control Enable for CLKOUT_PEG_B:	PMSRCCLK2[26] CLKRQ# Control Enable for CLKOUT_ITPXDP:	N/A
		PMSRCCLK2[3:0] CLKRQ# Select for CLKOUT_PEG_A (CRQSELPGEA):	PMSRCCLK2[7:4] CLKRQ# Select for CLKOUT_PEG_B (CRQSELPGEB):	PMSRCCLK2[11:8] CLKRQ# Select for CLKOUT_ITPXDP (CRQSELITPXDP)	
PI12BIASPARMS	PI12BIASPARMS[31:0] Chipset Configuration (PCHCFG)	PI12BIASPARMS[31:0] Chipset Configuration (PCHCFG)	PI12BIASPARMS[31:0] Chipset Configuration (PCHCFG)	PI12BIASPARMS[31:0] Chipset Configuration (PCHCFG)	N/A
No- OC Platform					
DIV2-S	(DIV2-S) Clock Div Min[] Clock Div Max[] Clock Usage []	(DIV2-S) Clock Div Min[] Clock Div Max[] Clock Usage []	(DIV2-S) Clock Div Min[] Clock Div Max[] Clock Usage []	(DIV2-S) Clock Div Min[] Clock Div Max[] Clock Usage []	(DIV2-S) Clock Div Min[] Clock Div Max[] Clock Usage []
SSC2PARMS	SSC2PARMS [31:0] Chipset Configuration (PCHCFG)	SSC2PARMS [31:0] Chipset Configuration (PCHCFG)	SSC2PARMS [31:0] Chipset Configuration (PCHCFG)	SSC2PARMS [31:0] Chipset Configuration (PCHCFG)	SSC2PARMS [31:0] Chipset Configuration (PCHCFG)
SSC2OCPARMS	SSC2OCPARMS [31:0] Chipset Configuration (PCHCFG)	SSC2OCPARMS [31:0] Chipset Configuration (PCHCFG)	SSC2OCPARMS [31:0] Chipset Configuration (PCHCFG)	SSC2OCPARMS [31:0] Chipset Configuration (PCHCFG)	SSC2OCPARMS [31:0] Chipset Configuration (PCHCFG)
OC Platform					
DIV2-S	(DIV2-S) Clock Div Min[] Clock Div Max[] Clock Usage []	(DIV2-S) Clock Div Min[] Clock Div Max[] Clock Usage []	(DIV2-S) Clock Div Min[] Clock Div Max[] Clock Usage []	(DIV2-S) Clock Div Min[] Clock Div Max[] Clock Usage []	N/A
DIV3	N/A	N/A	N/A	N/A	(DIV3) Clock Div Min[] Clock Div Max[] Clock Usage []
SSC2PARMS	SSC2PARMS [31:0] Chipset Configuration (PCHCFG)	SSC2PARMS [31:0] Chipset Configuration (PCHCFG)	SSC2PARMS [31:0] Chipset Configuration (PCHCFG)	SSC2PARMS [31:0] Chipset Configuration (PCHCFG)	N/A
SSC2OCPARMS	SSC2OCPARMS [31:0] Chipset Configuration (PCHCFG)	SSC2OCPARMS [31:0] Chipset Configuration (PCHCFG)	SSC2OCPARMS [31:0] Chipset Configuration (PCHCFG)	SSC2OCPARMS [31:0] Chipset Configuration (PCHCFG)	N/A

B.3.21 PCH Clock output / ICC registers mapping - part B

The following table map each one of the PCH outputs with the ICC registers bit that is configurable in the FITc tool (ICC profile).

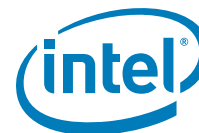

Table B-21. PCH Clock output / ICC registers mapping - part B (Sheet 1 of 5)

ICC Registers	CLKOUT_PCI[4:0]	CLKOUT_DP_BCLK1	CLKOUT_FLEX[3:0]	SATA
CSS	CSS[16:12] Chipset Configuration (PCHCFG)	CSS[9:3] Chipset Configuration (PCHCFG)	CSS[16:12] Chipset Configuration (PCHCFG)	CSS[16:12] Chipset Configuration (PCHCFG)
	CSS[2:0] PCI Clock Source Select (PCSS) (SSC2 or SSC3)		CSS[11:10] 24MHz/48MHz clock source select (24x48CSS)	
			CSS[2:0] PCI Clock Source Select (PCSS) (SSC2 or SSC3) NOTE: Only when configured to PCI	
SSS	SSS[20] DMI Port Clock Select (DMIPORTCS)	N/A	SSS[20] DMI Port Clock Select (DMIPORTCS) NOTE: Only when configured to PCI	SSS[20] DMI Port Clock Select (DMIPORTCS)
FCSS	N/A	N/A	FCSS[14:12] FLEXCLK3 Source Select (F3SS)	N/A
			FCSS[10:8] FLEXCLK2 Source Select (F2SS)	
			FCSS[6:4] FLEXCLK1 Source Select (F1SS)	
			FCSS[2:0] FLEXCLK0 Source Select (F0SS)	
DPLLAC/B	N/A	N/A	DPLLAC[30] DPLLAC[26:24] DPLLBC[30] NOTE: DPLLAC and DPLLBC are accessible only through XML file	N/A
PLLRCs	PLLRCs[19] Chipset Configuration (PCHCFG)	PLLRCs[16:2] Chipset Configuration (PCHCFG)	PLLRCs[19] Chipset Configuration (PCHCFG)	PLLRCs[19] Chipset Configuration (PCHCFG)
	PLLRCs[18:17] SSCn Source Select for PXP PLL		PLLRCs[18:17] SSCn Source Select for PXP PLL NOTE: Only when configured to PCI	PLLRCs[18:17] SSCn Source Select for PXP PLL (SATA)
	PLLRCs[16:2] Chipset Configuration (PCHCFG)		PLLRCs[16:2] Chipset Configuration (PCHCFG)	PLLRCs[16:2] Chipset Configuration (PCHCFG)
				PLLRCs[1:0] SATA PLL Reference Select (SATARS)



Table B-21. PCH Clock output / ICC registers mapping - part B (Sheet 2 of 5)

ICC Registers	CLKOUT_PCI[4:0]	CLKOUT_DP_BCLK1	CLKOUT_FLEX[3:0]	SATA
PPLEN	PPLEN[31] Chipset Strap (PCHHWSTRP) Note: this is a read only reg and cannot be set	PPLEN[31] Chipset Strap (PCHHWSTRP) Note: this is a read only reg and cannot be set	PPLEN[31] Chipset Strap (PCHHWSTRP) Note: this is a read only reg and cannot be set	PPLEN[31] Chipset Strap (PCHHWSTRP) Note: this is a read only reg and cannot be set
		PPLEN[10] SSC4 Ownership (SSC4OWN)		
		PPLEN[9] DPLLA/DPLLB/SSC1 Ownership (DPLLSSC1OWN)	PPLEN[9] DPLLA/DPLLB/SSC1 Ownership (DPLLSSC1OWN) Note: only if 27-MHz output is required	
	PPLEN[3:0] Chipset Configuration (PCHCFG)	PPLEN[3:0] Chipset Configuration (PCHCFG)	PPLEN[3:0] Chipset Configuration (PCHCFG)	PPLEN[3:0] Chipset Configuration (PCHCFG)
OCKEN	OCKEN[11:7] PCICLK 4:0 Output Clock Enable (PCI4OOCKEN)	OCKEN[24] DP120 Output Clock Enable (DPOCKEN)	OCKEN[3:0] FLEXCLK 3:0 Output Clock Enable (FLEX3OOCKEN)	N/A
IBEN	For FCIM configuration, use default values			
DIVEN	DIVEN[4] DIV3 Enable (DIV3EN)	DIVEN[8] DIV7 Enable (DIV7EN)	DIVEN[10] 14.31818Mhz Fractional Divisor Enable (14FDEN)	DIVEN[4] DIV3 Enable (DIV3EN)
			DIVEN[8] DIV7 Enable (DIV7EN)	
			DIVEN[7] DIV5 Stage 2 Enable (DIV5BEN)	
		DIVEN[5] DIV4 Enable (DIV4EN)	DIVEN[6] DIV5 Stage 1 Enable (DIV5AEN)	
	DIVEN[3] DIV2-S Enable (DIV2SEN)	DIVEN[1] DIV1-S Enable (DIV1SEN)	DIVEN[4] DIV3 Enable (DIV3EN) NOTE: Only when configured to PCI	DIVEN[3] DIV2-S Enable (DIV2SEN) NOTE: Only when configured to PCI
			DIVEN[3] DIV2-S Enable (DIV2SEN)	
			DIVEN[1] DIV1-S Enable (DIV1SEN)	
	DIVEN[0] DIV1-NS Enable (DIV1NSEN)	DIVEN[0] DIV1-NS Enable (DIV1NSEN)		

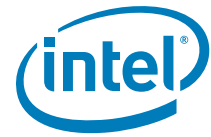

Table B-21. PCH Clock output / ICC registers mapping - part B (Sheet 3 of 5)

ICC Registers	CLKOUT_PCI[4:0]	CLKOUT_DP_BCLK1	CLKOUT_FLEX[3:0]	SATA
PM1	N/A	PM1[4] Dynamic SSC1 Shutdown Enable (SSC1DSEN)	PM1[4] Dynamic SSC1 Shutdown Enable (SSC1DSEN)	N/A
		PM1[3:2] Dynamic SSC4 and DIV4 Shutdown Enable (SSC4DIV4DSEN)		
		PM1[1] Dynamic DIV1-NS Shutdown Enable (DIV1NSDSEN)		
		PM1[0] Dynamic DIV1-S Shutdown Enable (DIV1SDSEN)	PM1[0] Dynamic DIV1-S Shutdown Enable (DIV1SDSEN)	
PM2	PM2[4:0] CLKRUN Control Enable (CLKRUNCEN)	N/A	PM2[8:5] CLKRUN Control Enable for PCI 33 Mhz on CLKOUTFLEX (CLKRUNCEN_FLEX)	N/A
SEBP1	N/A	N/A	SEBP1[15:13] FLEXCLK3 Slew Rate Control (F3SLC)	N/A
			SEBP1[12] FLEXCLK3 Single/Double Load Series Resistance (F3SDLSR)	
			SEBP1[11:9] FLEXCLK2 Slew Rate Control (F2SLC)	
			SEBP1[8] FLEXCLK2 Single/Double Load Series Resistance (F2SDLSR)	
			SEBP1[7:5] FLEXCLK1 Slew Rate Control (F1SLC)	
			SEBP1[4] FLEXCLK1 Single/Double Load Series Resistance (F1SDLSR)	
			SEBP1[3:1] FLEXCLK0 Slew Rate Control (F2SLC)	
			SEBP1[0] FLEXCLK0 Single/Double Load Series Resistance (F0SDLSR)	



Table B-21. PCH Clock output / ICC registers mapping - part B (Sheet 4 of 5)

ICC Registers	CLKOUT_PCI[4:0]	CLKOUT_DP_BCLK1	CLKOUT_FLEX[3:0]	SATA
SEBP2	SEBP2[19:17] PCI4 Slew Rate Control (PCI3SLC)	N/A	N/A	N/A
	SEBP2[16] PCI4 Single/Double Load Series Resistance (PCI4SDLSR)			
	SEBP2[15:13] PCI3 Slew Rate Control (PCI3SLC)			
	SEBP2[12] PCI3 Single/Double Load Series Resistance (PCI3SDLSR)			
	SEBP2[11:9] PCI2 Slew Rate Control (PCI2SLC)			
	SEBP2[8] PCI2 Single/Double Load Series Resistance (PCI2SDLSR)			
	SEBP2[7:5] PCI1 Slew Rate Control (PCI1SLC)			
	SEBP2[4] PCI1 Single/Double Load Series Resistance (PCI1SDLSR)			
	SEBP2[3:1] PCI0 Slew Rate Control (PCI0SLC)			
	SEBP2[0] PCI0 Single/Double Load Series Resistance (PCI0SDLSR)			
SSCCTL	SSCCTL[18:17] SSC3 Spread Mode (SSC3_SprdMd)	SSCCTL[26:25] SSC4 Spread Mode (SSC4_SprdMd)	SSCCTL[2:1] SSC1 Spread Mode (SSC1_SprdMd)	N/A
	SSCCTL[16] SSC3 Enable, Active Low (SSC3_EnB)	SSCCTL[24] SSC4 Enable, Active Low (SSC4_EnB)		
	SSCCTL[10:9] SSC2 Spread Mode (SSC2_SprdMd)	SSCCTL[2:1] SSC1 Spread Mode (SSC1_SprdMd)	SSCCTL[0] SSC1 Enable, Active Low (SSC1_EnB)	
	SSCCTL[8] SSC2 Enable, Active Low (SSC2_EnB)	SSCCTL[0] SSC1 Enable, Active Low (SSC1_EnB)		
PMSRCCLK1	N/A	N/A	N/A	N/A
PMSRCCLK2	N/A	N/A	N/A	N/A
PI12BIASPA RMS	N/A	N/A	N/A	N/A
No- OC Platform				

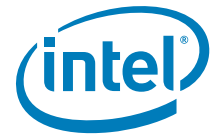

Table B-21. PCH Clock output / ICC registers mapping - part B (Sheet 5 of 5)

ICC Registers	CLKOUT_PCI [4:0]	CLKOUT_DP_BCLK1	CLKOUT_FLEX [3:0]	SATA
DIV2-S Clock Div Min[] Clock Div Max[] Clock Usage []	(DIV2-S) Clock Div Min[] Clock Div Max[] Clock Usage []	N/A	(DIV2-S) Clock Div Min[] Clock Div Max[] Clock Usage [] NOTE: Only when configured to PC	(DIV2-S) Clock Div Min[] Clock Div Max[] Clock Usage []
SSC2PARMS	SSC2PARMS [31:0] Chipset Configuration (PCHCFG)	N/A	SSC2PARMS [31:0] Chipset Configuration (PCHCFG) NOTE: Only when configured to PC	SSC2PARMS [31:0] Chipset Configuration (PCHCFG)
SSC2OCPARMS	SSC2OCPARMS [31:0] Chipset Configuration (PCHCFG)	N/A	SSC2OCPARMS [31:0] Chipset Configuration (PCHCFG) NOTE: Only when configured to PC	SSC2OCPARMS [31:0] Chipset Configuration (PCHCFG)
OC Platform				
DIV2-S	N/A	N/A	N/A	N/A
DIV3 Clock Div Min[] Clock Div Max[] Clock Usage []	(DIV3) Clock Div Min[] Clock Div Max[] Clock Usage []	N/A	(DIV3) Clock Div Min[] Clock Div Max[] Clock Usage [] NOTE: Only when configured to PC	(DIV3) Clock Div Min[] Clock Div Max[] Clock Usage []
SSC2PARMS	N/A	N/A	N/A	N/A
SSC2OCPARMS	N/A	N/A	N/A	N/A

B.3.22 ICC SKU Support Matrix

The following table describes features, clock range (maximum and minimum), spread mode supported by Intel® 7 Series/C216 Chipset Family PCH SKU. The ICC SKU is divided into 3 categories; Basic, enhanced, and Extreme.

Table B-22. ICC SKU Matrix

PCH SKU	Basic	Enhanced	Extreme
Q77		X	
Q75		X	
B75	X		
H77		X	
Z77			X
Z75			X
H71	X		
QM77			X
QS77			X
UM77			X
HM77			X



Table B-22. ICC SKU Matrix

PCH SKU	Basic	Enhanced	Extreme
HM76	X		
HM75	X		
HM70	X		
C216	X		
Features Supported	Display Clock Bending	Display Clock Bending Adaptive Clocking (Wimax Friendly Clocking)	Display Clock Bending Adaptive Clocking (Wimax Friendly Clocking) CPU BCLK Overclocking
Clock Range Supported	1. SSC2 (DIV2-S) [Min - Max] = 100 MHz (0xC00) 2. SSC3 (DIV3) = Locked	1. SSC2 (DIV2-S) [Min - Max] = 99.5463-100 MHz (0xC0E - 0xC00) 2. SSC3 (DIV3) [Min - Max] = 99.5463-100 MHz (0xC0E - 0xC00)	1. SSC2 (DIV2-S) [Min - Max] = 99.5463-800 ** MHz (0xC0E - 0x180) 2. SSC3 (DIV3) [Min - Max] = 99.5463-100 MHz (0xC0E - 0xC00)
Spread Mode Supported	SSC1-3 = Down SSC4 = Down , Center	SSC1-3 = Down SSC4 = Down , Center	SSC2 = Down, Center * SSC1, SSC3 = Down SSC4 = Down , Center
Max Spread % supported	Intel® 7 Series/C216 Chipset Family PCH HW support Max Spread % for SSC1-3 = 0.5% and SSC4 = 2.5%		

Min = Clock Div Max (minimum allowed frequency)

Max = Clock Div Min (maximum allowed frequency)

* Center spread is only allow when platform is configured for overclocking configuration, where all non-overclockable clocks (PCI, PCIe, etc..) are routed to SSC3 source.

Note that enabling center spread will add a small overclocking to the nominal frequency. This places the platform in an unsupported configuration and/or operational state and can result in platform instability, physical damage, and data loss. These margins are not guaranteed or supported.

** Intel® ME firmware ensure that if ME clock is on SSC2, then SSC2 frequency cannot be exceed 100MHz and it will also disable center spread support.

Note: By default, all the SSC blocks are configured to generate a spread spectrum of 0.5% down spread mode.

§ §