

Q370D4-P1

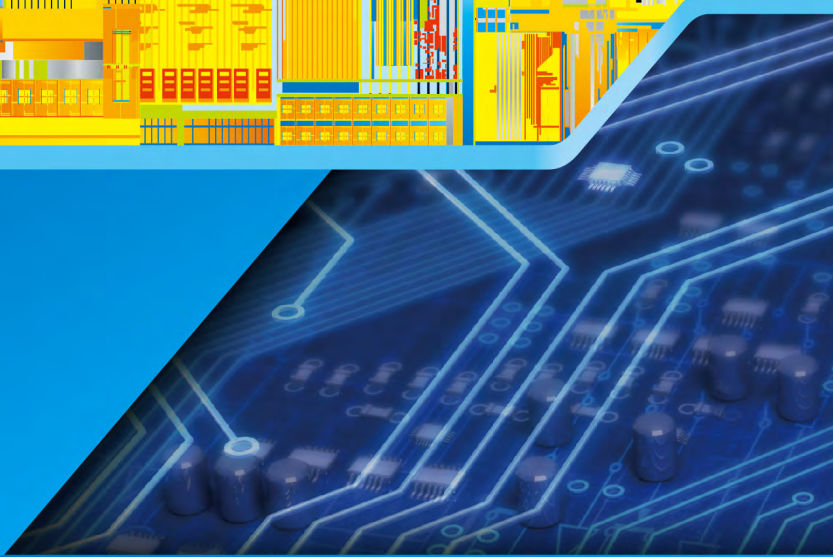

Version 1.0

Published August 2018

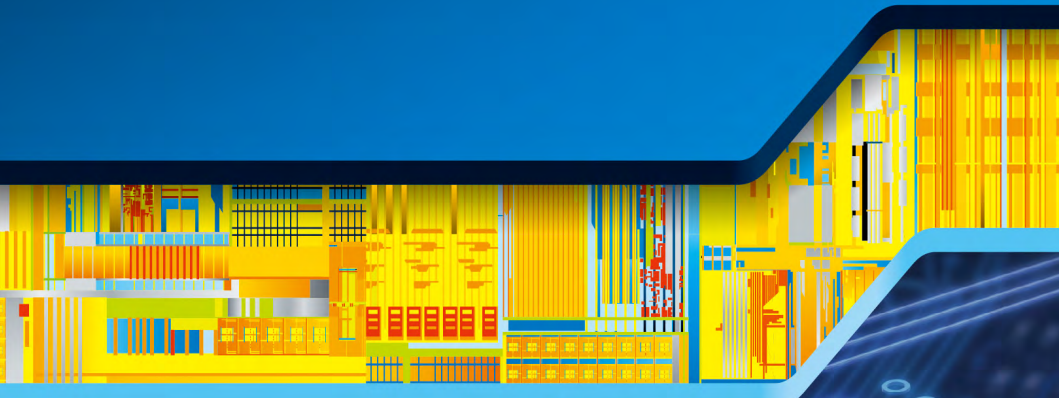

This device complies with Part 15 of the FCC Rules. Operation is subject to the following two conditions:

- (1) this device may not cause harmful interference, and
- (2) this device must accept any interference received, including interference that may cause undesired operation.

CALIFORNIA, USA ONLY

The Lithium battery adopted on this motherboard contains Perchlorate, a toxic substance controlled in Perchlorate Best Management Practices (BMP) regulations passed by the California Legislature. When you discard the Lithium battery in California, USA, please follow the related regulations in advance.

“Perchlorate Material-special handling may apply, see www.dtsc.ca.gov/hazardouswaste/perchlorate”

AUSTRALIA ONLY

Our goods come with guarantees that cannot be excluded under the Australian Consumer Law. You are entitled to a replacement or refund for a major failure and compensation for any other reasonably foreseeable loss or damage caused by our goods. You are also entitled to have the goods repaired or replaced if the goods fail to be of acceptable quality and the failure does not amount to a major failure.

The terms HDMI® and HDMI High-Definition Multimedia Interface, and the HDMI logo are trademarks or registered trademarks of HDMI Licensing LLC in the United States and other countries.



Contents

Chapter 1 Introduction	1
1.1 Package Contents	1
1.2 Specifications	2
1.3 Motherboard Layout	6
1.4 Front Panel	8
1.5 Rear Panel	9
Chapter 2 Installation	10
2.1 Installing the CPU	11
2.2 Installing the CPU Fan and Heatsink	14
2.3 Installing Memory Modules (SO-DIMM)	15
2.4 Jumpers Setup	16
2.5 Onboard Headers and Connectors	17
2.6 Smart Switch	19
2.7 M.2 WiFi/BT Module Installation Guide	20
2.8 M.2_SSD (NGFF) Module Installation Guide (M2_1)	22
Chapter 3 Software and Utilities Operation	24
3.1 Installing Drivers	24
Chapter 4 UEFI SETUP UTILITY	25
4.1 Introduction	25
4.1.1 UEFI Menu Bar	25
4.1.2 Navigation Keys	26

4.2	Main Screen	27
4.3	Advanced Screen	28
4.3.1	CPU Configuration	29
4.3.2	DRAM Configuration	32
4.3.3	Chipset Configuration	33
4.3.4	Storage Configuration	35
4.3.5	Super IO Configuration	36
4.3.6	ACPI Configuration	37
4.3.7	USB Configuration	38
4.3.8	Trusted Computing	39
4.4	Tools	40
4.5	Hardware Health Event Monitoring Screen	41
4.6	Security Screen	42
4.7	Boot Screen	43
4.8	Exit Screen	46

Chapter 1 Introduction

Thank you for purchasing Q370D4-P1 motherboard. In this documentation, Chapter 1 and 2 contains the introduction of the motherboard and step-by-step installation guides. Chapter 3 contains the operation guide of the software and utilities. Chapter 4 contains the configuration guide of the BIOS setup.



Because the motherboard specifications and the BIOS software might be updated, the content of this documentation will be subject to change without notice.

1.1 Package Contents

- Q370D4-P1 Motherboard
- Q370D4-P1 Quick Installation Guide
- Q370D4-P1 Support CD
- 1 x Serial ATA(SATA) Data with Power Cable (Optional)
- 1 x Screw for M.2 Socket (M2*2) (Optional)
- 1 x Screw for WiFi Module (M2*2) (Optional)

1.2 Specifications

Platform • 6.7-in x 6.8-in, 17.0 cm x 17.2 cm

CPU

- Supports 8th Generation Intel® Core™ Processors (Socket 1151)
- Supports CPU up to 65W
- 5 Power Phase design
- Supports Intel® Turbo Boost 2.0 Technology

Chipset

- Intel® Q370
- Supports Intel® vPro™ Technology
- Supports Intel® Active Management Technology 12.0

* Intel® vPro™ Technology and Intel® Active Management Technology 12.0 can be supported only with Intel® Core™ vPro™ processor family

Memory

- Dual Channel DDR4 Memory Technology
- 2 x DDR4 SO-DIMM Slots
- Supports DDR4 2666/2400/2133 non-ECC, un-buffered memory
- Max. capacity of system memory: 32GB
- Supports Intel® Extreme Memory Profile (XMP) 2.0

Expansion Slot

- 1 x M.2 Socket (Key E), supports type 2230 WiFi/BT module

Graphics

- Intel® UHD Graphics Built-in Visuals and the VGA outputs can be supported only with processors which are GPU integrated.
- Supports Intel® UHD Graphics Built-in Visuals : Intel® Quick Sync Video with AVC, MVC (S3D) and MPEG-2 Full HW Encode1, Intel® InTru™ 3D, Intel® Clear Video HD Technology, Intel® Insider™, Intel® UHD Graphics
- DirectX 12
- HWAEncode/Decode: AVC/H.264, HEVC/H.265 8-bit, HEVC/H.265 10-bit, VP8, VP9 8-bit, VP9 10-bit (Decode only), MPEG2, MJPEG, VC-1 (Decode only)

- Max. shared memory 1024MB
- * The size of maximum shared memory may vary from different operating systems.
- Four graphics output options: DisplayPort 1.2, DisplayPort 1.2, HDMI and D-Sub
- * Supports up to 3 displays simultaneously
- Supports HDMI with max. resolution up to 4K x 2K (4096x2160) @ 30Hz
- Supports D-Sub with max. resolution up to 1920x1200 @ 60Hz
- Supports DisplayPort 1.2 with max. resolution up to 4K x 2K (4096x2304) @ 60Hz
- Supports Auto Lip Sync, Deep Color (12bpc), xvYCC and HBR (High Bit Rate Audio) with HDMI Port (Compliant HDMI monitor is required)
- Supports HDCP with HDMI and DisplayPort 1.2 Ports
- Supports 4K Ultra HD (UHD) playback with HDMI and DisplayPort 1.2 Ports

Audio

- Realtek ALC233-VB2 Audio Codec
- 1 x Headphone/Headset Jack
- 1 x MIC-In

LAN

- Gigabit LAN 10/100/1000 Mb/s
- Giga PHY Intel® I219LM
- Supports Wake-On-LAN
- Supports Lightning/ESD Protection
- Supports Energy Efficient Ethernet 802.3az
- Supports PXE

Front Panel I/O

- 1 x Power Button
- 1 x Headphone/Headset Jack
- 2 x USB 3.1 Gen1 Type-A Ports (Supports ESD Protection)
- 2 x USB 3.1 Gen2 Type-C Ports (Supports ESD Protection)
- 1 x Microphone Input Jack

Rear Panel I/O

- 1 x DC Jack (Compatible with the 19V power adapter)*
- * Please use 90W power adapter for 65W CPU and 65W power adapter for 35W CPU.
- 1 x Headphone Jack
- 1 x HDMI Port
- 2 x DisplayPort 1.2
- 4 x USB 3.1 Gen1 Ports (Support ESD Protection)
- 1 x RJ-45 LAN Port with LED (ACT/LINK LED and SPEED LED)

Storage

- 1 x SATA3 6.0 Gb/s with Power Connector , support NCQ, AHCI and Hot Plug
- 1 x Ultra M.2 Socket, support type 2280 M.2 SATA3 6.0 Gb/s module and M.2 PCI Express module up to Gen3 x4 (32 Gb/s)*
- * Supports Intel® Optane™ Technology
- * Supports NVMe SSD as boot disks

Connector

- 1 x D-Sub Header
- 1 x COM Port Header
- 1 x Chassis Intrusion Header
- 1 x CPU Fan Connector (4-pin)
- 1 x Internal Speaker Header
- 1 x Mono-Out Header
- 1 x ROM Recovery Header

BIOS Feature

- AMI UEFI Legal BIOS with multilingual GUI support
- ACPI 6.0 Compliant wake up events
- SMBIOS 2.7 Support

Hardware Monitor

- CPU Temperature Sensing
- CPU Fan Tachometer
- CPU Quiet Fan (Auto adjust chassis fan speed by CPU temperature)
- CPU Fan Multi-Speed Control
- CASE OPEN detection
- Voltage monitoring: +12V, +5V, +3.3V, CPU Vcore

OS

- Microsoft® Windows® 10 64-bit

Certifications

- FCC, CE
- ErP/EuP ready (ErP/EuP ready power supply is required)



Please realize that there is a certain risk involved with overclocking, including adjusting the setting in the BIOS, applying Untied Overclocking Technology, or using third-party overclocking tools. Overclocking may affect your system's stability, or even cause damage to the components and devices of your system. It should be done at your own risk and expense. We are not responsible for possible damage caused by overclocking.

1.3 Motherboard Layout

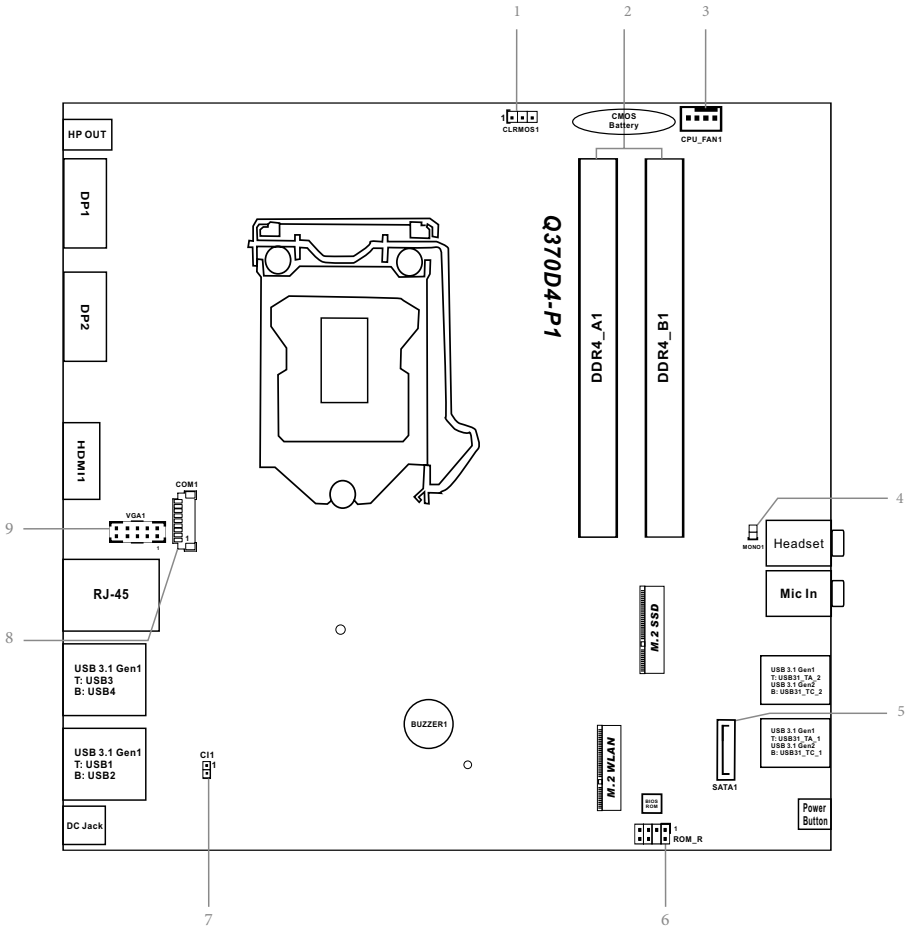

No.	Description
1	Clear CMOS Jumper (CLRMOS1)
2	2 x 260-pin DDR4 SO-DIMM Slots (DDR4_A1, DDR4_B1)
3	CPU Fan Connector (CPU_FAN1)
4	2.5W Mono Out Speaker Header (MONO1)
5	SATA3 Connector (SATA0)
6	ROM Recovery Header (ROM_R)
7	Chassis Intrusion Header (CI1)
8	COM Port Header (COM1)
9	D-Sub Header (VGA1)

1.4 Front Panel

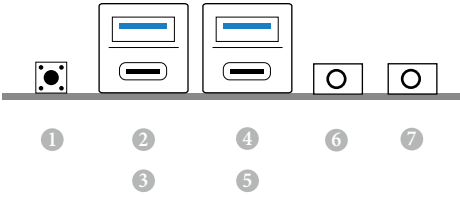

No.	Description	No.	Description
1	Power Button (SW1)	5	USB 3.1 Gen2 Type-C Port (USB31_TC_2)
2	USB 3.1 Gen1 Type-A Port (USB31_TA_1)	6	Microphone Input (AUDIO2)
3	USB 3.1 Gen2 Type-C Port (USB31_TC_1)	7	Headphone/Headset Jack
4	USB 3.1 Gen1 Type-A Port (USB31_TA_2)		

1.5 Rear Panel

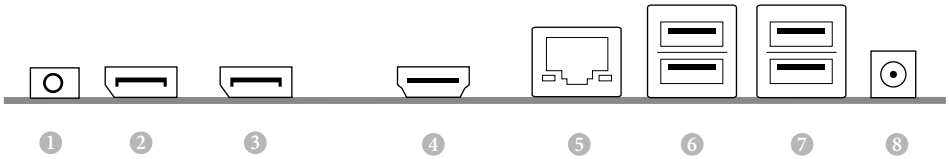

No.	Description	No.	Description
1	Headphone Jack	5	LAN RJ-45 Port*
2	DisplayPorts 1.2 (DP1)	6	USB 3.1 Gen1 Ports (USB3_34)
3	DisplayPorts 1.2 (DP2)	7	USB 3.1 Gen1 Ports (USB3_12)
4	HDMI Port	8	DC Jack

* There are two LEDs on each LAN port. Please refer to the table below for the LAN port LED indications.

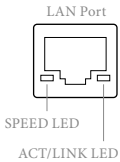

Activity / Link LED		Speed LED	
Status	Description	Status	Description
Off	No Link	Off	10Mbps connection
Blinking	Data Activity	Green	100Mbps connection
On	Link	Orange	1Gbps connection

Chapter 2 Installation

This is a Proprietary form factor motherboard. Before you install the motherboard, study the configuration of your chassis to ensure that the motherboard fits into it.

Pre-installation Precautions

Take note of the following precautions before you install motherboard components or change any motherboard settings.

- Make sure to unplug the power cord before installing or removing the motherboard components. Failure to do so may cause physical injuries and damages to motherboard components.
- In order to avoid damage from static electricity to the motherboard's components, NEVER place your motherboard directly on a carpet. Also remember to use a grounded wrist strap or touch a safety grounded object before you handle the components.
- Hold components by the edges and do not touch the ICs.
- Whenever you uninstall any components, place them on a grounded anti-static pad or in the bag that comes with the components.
- When placing screws to secure the motherboard to the chassis, please do not over-tighten the screws! Doing so may damage the motherboard.

2.1 Installing the CPU



1. Before you insert the 1151-Pin CPU into the socket, please check if the **PnP cap** is on the socket, if the CPU surface is unclean, or if there are any **bent pins** in the socket. Do not force to insert the CPU into the socket if above situation is found. Otherwise, the CPU will be seriously damaged.
2. Unplug all power cables before installing the CPU.

1

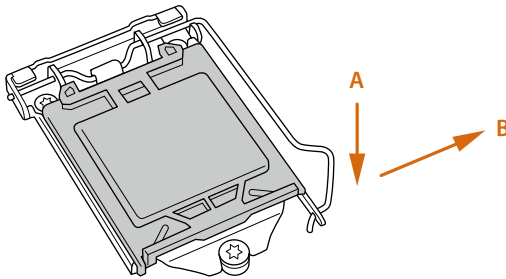

2

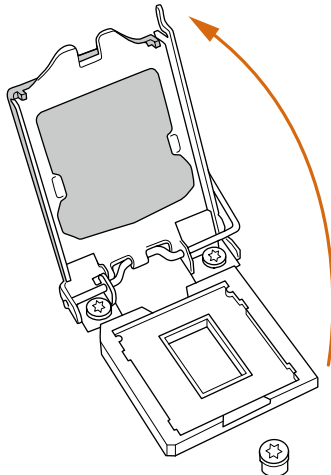

3

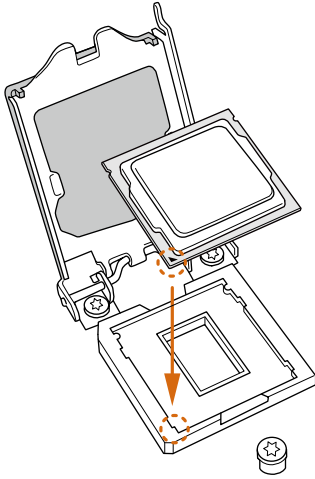

4

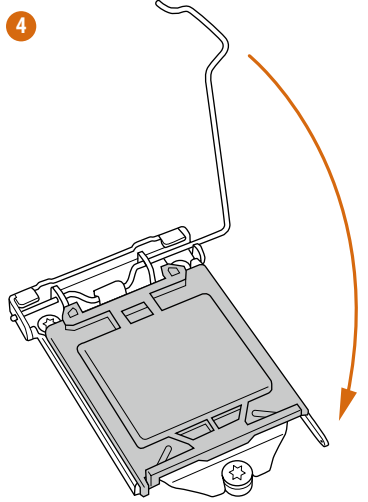

5

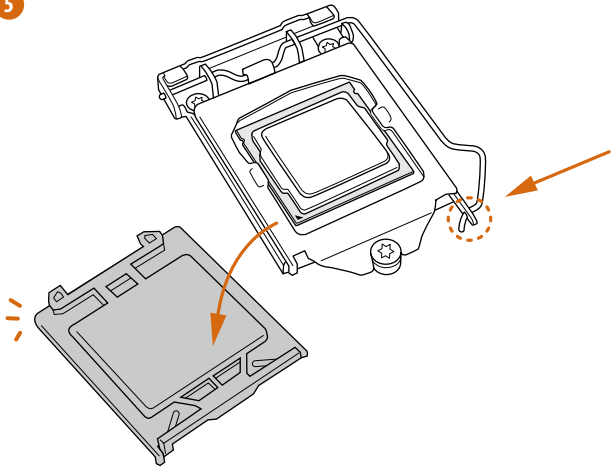



Please save and replace the cover if the processor is removed. The cover must be placed if you wish to return the motherboard for after service.

2.2 Installing the CPU Fan and Heatsink

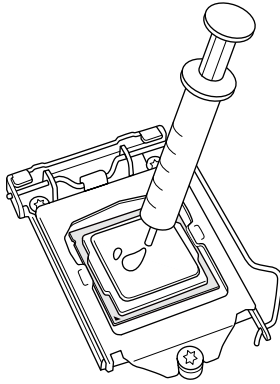

1

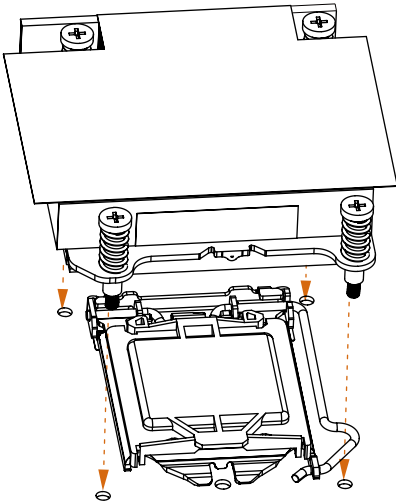

2

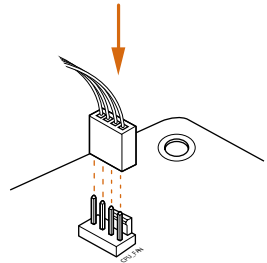

2.3 Installing Memory Modules (SO-DIMM)

This motherboard provides two 260-pin DDR4 (Double Data Rate 4) SO-DIMM slots.



It is not allowed to install a DDR, DDR2 or DDR3 memory module into a DDR4 slot; otherwise, this motherboard and SO-DIMM may be damaged.



The SO-DIMM only fits in one correct orientation. It will cause permanent damage to the motherboard and the SO-DIMM if you force the SO-DIMM into the slot at incorrect orientation.

1. Carefully insert the SO-DIMM memory modules into the slot at a 30-degree angle.

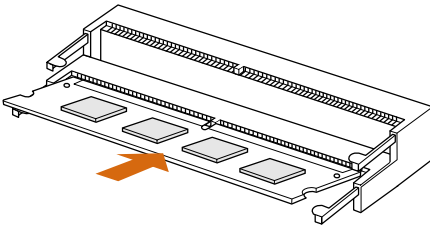

2. Push down until the modules snap into place.

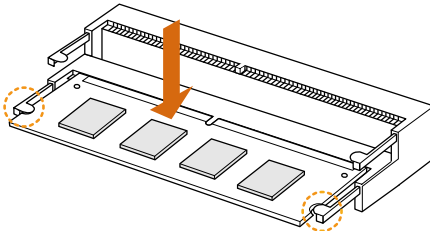

2.4 Jumpers Setup

The illustration shows how jumpers are setup. When the jumper cap is placed on the pins, the jumper is “Short”. If no jumper cap is placed on the pins, the jumper is “Open”. The illustration shows a 3-pin jumper whose pin1 and pin2 are “Short” when a jumper cap is placed on these 2 pins.

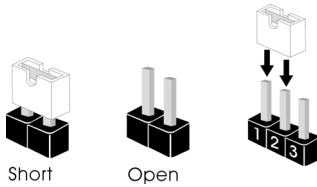

Clear CMOS Jumper
(CLRMOSt)
(see p.6, No. 1)

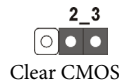

CLRMOSt allows you to clear the data in CMOS. To clear and reset the system parameters to default setup, please turn off the computer and unplug the power cord from the power supply. After waiting for 15 seconds, use a jumper cap to short pin2 and pin3 on CLRMOSt for 5 seconds. However, please do not clear the CMOS right after you update the BIOS. If you need to clear the CMOS when you just finish updating the BIOS, you must boot up the system first, and then shut it down before you do the clear-CMOS action. Please be noted that the password, date, time, and user default profile will be cleared only if the CMOS battery is removed.



1. The Clear CMOS Button has the same function as the Clear CMOS jumper.
2. If you clear the CMOS, the case open may be detected. Please adjust the BIOS option “Clear Status” to clear the record of previous chassis intrusion status.

2.5 Onboard Headers and Connectors



Onboard headers and connectors are NOT jumpers. Do NOT place jumper caps over these headers and connectors. Placing jumper caps over the headers and connectors will cause permanent damage to the motherboard.

Serial ATA3 Connector
(SATA0:
see p.6, No. 5)



This SATA3 connector supports SATA data cables for internal storage devices with up to 6.0 Gb/s data transfer rate.

CPU Fan Connectors
(4-pin CPU_FAN1)
(see p.6, No. 3)

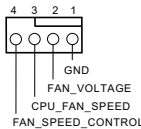

This motherboard provides a 4-Pin CPU fan (Quiet Fan) connector. If you plan to connect a 3-Pin CPU fan, please connect it to Pin 1-3.

Serial Port Header
(9-pin COM1)
(see p.6, No. 8)

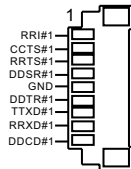

This COM1 header supports a serial port module.

Chassis Intrusion Header
(2-pin CII)
(see p.6, No. 7)

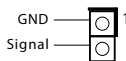

This motherboard supports CASE OPEN detection feature that detects if the chassis cover has been removed. This feature requires a chassis with chassis intrusion detection design.

2.5W Audio Amp Output Header
(2-pin MONO1)
(see p.6, No. 4)

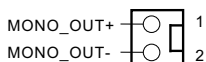

Please connect the chassis speaker to this header.

ROM Recovery Header
(7-pin ROM_R)
(see p.6, No. 6)

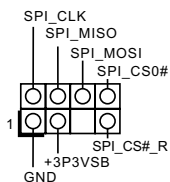

This ROM Recovery Connector allows qualified technicians to reload firmware into the SPI boot flash in case there is problem with the data.

D-Sub Header
(10-pin VGA1)
(see p.6, No. 9)

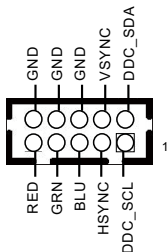

This header is to connect a D-Sub monitor via an adapter cable

2.6 Smart Switch

The motherboard has one smart switch: Power Button.

Power Button
(SW1)
(see p.8, No. 1)



Power Button allows users to quickly turn on/off the system.

2.7 M.2 WiFi/BT Module Installation Guide

The M.2, also known as the Next Generation Form Factor (NGFF), is a small size and versatile card edge connector that aims to replace mPCIe and mSATA. The M.2 Socket (Key E) supports type 2230 WiFi/BT module.

* The M.2 socket does not support SATA M.2 SSDs.

Installing the WiFi/BT module

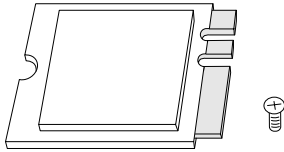

Step 1

Prepare a type 2230 WiFi/BT module and the screw.

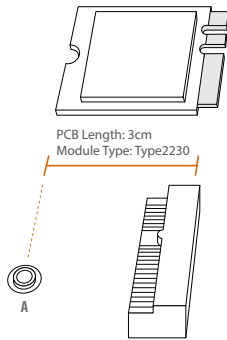

Step 2

Find the nut location to be used.

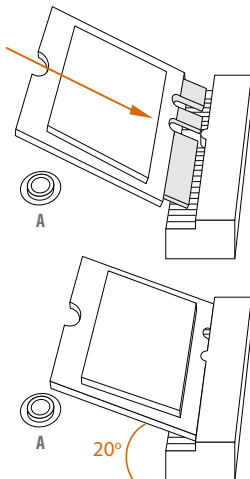

Step 3

Gently insert the WiFi/BT module into the M.2 slot. Please be aware that the module only fits in one orientation.

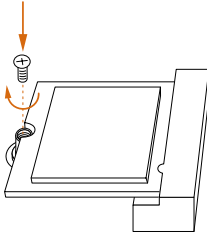
**Step 4**

Tighten the screw with a screwdriver to secure the module into place. Please do not overtighten the screw as this might damage the module.

2.8 M.2_SSD (NGFF) Module Installation Guide (M2_1)

The Ultra M.2, also known as the Next Generation Form Factor (NGFF), is a small size and versatile card edge connector that aims to replace mPCIe and mSATA. The Ultra M.2 Socket (M2_1) supports SATA3 6.0 Gb/s module and M.2 PCI Express module up to Gen3 x4 (32 Gb/s).

Installing the M.2_SSD (NGFF) Module

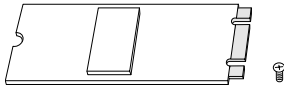

Step 1

Prepare a M.2_SSD (NGFF) module and the screw.

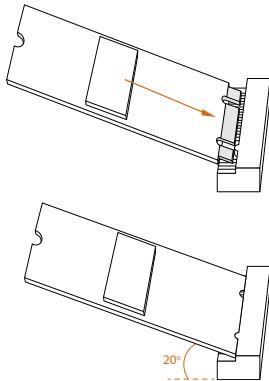

Step 2

Gently insert the M.2 (NGFF) SSD module into the M.2 slot. Please be aware that the M.2 (NGFF) SSD module only fits in one orientation.

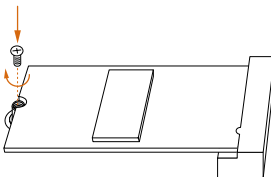

Step 3

Tighten the screw with a screwdriver to secure the module into place. Please do not overtighten the screw as this might damage the module.

M.2_SSD (NGFF) Module Support List

Vendor	Interface	P/N
ADATA	PCIe	ADATA ASX7000NPC-512GT-C (XPG SX7000) (NVMe)
ADATA	PCIe	ADATA ASX8000NPC-512GM-C (XPG ASX8000) (NVMe)
Apacer	PCIe	Apacer Z280 AP240GZ280-240G (NVMe)
Intel	PCIe	Intel Optane Memory 32GB (MEMPEK1W032GA)(NVMe)
Intel	PCIe	Intel Optane Memory 16GB (MEMPEK1W016GA)(NVMe)
INTEL	PCIe	INTEL 600P-SSDPEKKW256G7-256GB (NVMe)
INTEL	PCIe	INTEL 600P-SSDPEKKW128G7-128GB (NVMe)
INTEL	PCIe	INTEL 6000P-SSDPEKKF256G7-256GB (NVMe)
INTEL	PCIe	INTEL 6000P-SSDPEKKF512G7-512GB (NVMe)
Kingston	PCIe	Kingston SHPM2280P2/240G
PATRIOT	PCIe	PATRIOT Hellfire M2 (240G) (NVMe)
PLEXTOR	PCIe	PLEXTOR PX-256M8PeG (NVMe)
PLEXTOR	PCIe	PLEXTOR PX-256M8SeGN (NVMe)
Samsung	PCIe	Samsung XP941-512G (MZHPU512HCGL)
Samsung	PCIe	Samsung 950Pro-512G (NVMe)
Samsung	PCIe	Samsung 950Pro-256G (NVMe)
Samsung	PCIe	Samsung MZ-VLW1280 (PM961) (NVMe)
Samsung	PCIe	Samsung MZ-VPW1280 (SM961) (NVMe)
TOSHIBA	PCIe	TOSHIBA XG3-128G (NVMe)
TOSHIBA	PCIe	TOSHIBA OCZ RD400-256G (NVMe)
WD	PCIe	WD WDS512G1X0C-00ENX0 (NVMe)
WD	PCIe	WD WDS256G1X0C-00ENX0 (NVMe)
ADATA	SATA	ADATA - SU800-SU800NS38-256GT-C-256G
ADATA	SATA	ADATA - SU800-SU800NS38-512GT-C-512G
Crucial	SATA	Crucial-CT240M500SSD4-240GB
Ezlink	SATA	Ezlink P51B-80-120GB
INTEL	SATA	INTEL-535-SSDSCKJF240A5-QS63-MLC-240G
INTEL	SATA	INTEL 540S-SSDSCKKW240H6-240GB
Kingston	SATA	Kingston-RBU-SNS8400S3/180GD
LITON	SATA	LITON LJH-256V2G-11-256GB
PLEXTOR	SATA	PLEXTOR - M7V-PX-128M7VG-128GB
PLEXTOR	SATA	PLEXTOR PX-128M6G-128GB
Sandisk	SATA	Sandisk X400-SD8SN8U-128G
Sandisk	SATA	Sandisk Z400s-SD8SNAT-128G
Transcend	SATA	Transcend TS256GMTS800-256GB
V-Color	SATA	V-Color 120G
V-Color	SATA	V-Color 240G
WD	SATA	WD BLUE WDS100T1B0B
WD	SATA	WD Green WDS240G1G0B-00RC30

For the latest updates of M.2_SSD (NFGG) module support list, please visit our website for details.

Chapter 3 Software and Utilities Operation

3.1 Installing Drivers

The Support CD that comes with the motherboard contains necessary drivers and useful utilities that enhance the motherboard's features.

Running The Support CD

To begin using the support CD, insert the CD into your CD-ROM drive. The CD automatically displays the Main Menu if "AUTORUN" is enabled in your computer. If the Main Menu does not appear automatically, locate and double click on the file "ASRSETUP.EXE" in the Support CD to display the menu.

Drivers Menu

The drivers compatible to your system will be auto-detected and listed on the support CD driver page. Please click **Install All** or follow the order from top to bottom to install those required drivers. Therefore, the drivers you install can work properly.

Utilities Menu

The Utilities Menu shows the application software that the motherboard supports. Click on a specific item then follow the installation wizard to install it.

Chapter 4 UEFI SETUP UTILITY

4.1 Introduction

This section explains how to use the UEFI SETUP UTILITY to configure your system. You may run the UEFI SETUP UTILITY by pressing <F2> or right after you power on the computer, otherwise, the Power-On-Self-Test (POST) will continue with its test routines. If you wish to enter the UEFI SETUP UTILITY after POST, restart the system by pressing <Ctl> + <Alt> + <Delete>, or by pressing the reset button on the system chassis. You may also restart by turning the system off and then back on.



Because the UEFI software is constantly being updated, the following UEFI setup screens and descriptions are for reference purpose only, and they may not exactly match what you see on your screen.

4.1.1 UEFI Menu Bar

The top of the screen has a menu bar with the following selections:

Main	For setting system time/date information
Advanced	For advanced system configurations
Tool	Useful tools
H/W Monitor	Displays current hardware status
Boot	For configuring boot settings and boot priority
Security	For security settings
Exit	Exit the current screen or the UEFI Setup Utility

4.1.2 Navigation Keys

Use <←→> key or <→> key to choose among the selections on the menu bar, and use <↑> key or <↓> key to move the cursor up or down to select items, then press <Enter> to get into the sub screen. You can also use the mouse to click your required item.

Please check the following table for the descriptions of each navigation key.

Navigation Key(s)	Description
+ / -	To change option for the selected items
<Tab>	Switch to next function
<PGUP>	Go to the previous page
<PGDN>	Go to the next page
<HOME>	Go to the top of the screen
<END>	Go to the bottom of the screen
<F1>	To display the General Help Screen
<F7>	Discard changes and exit the SETUP UTILITY
<F9>	Load optimal default values for all the settings
<F10>	Save changes and exit the SETUP UTILITY
<F12>	Print screen
<ESC>	Jump to the Exit Screen or exit the current screen

4.2 Main Screen

When you enter the UEFI SETUP UTILITY, the Main screen will appear and display the system overview.

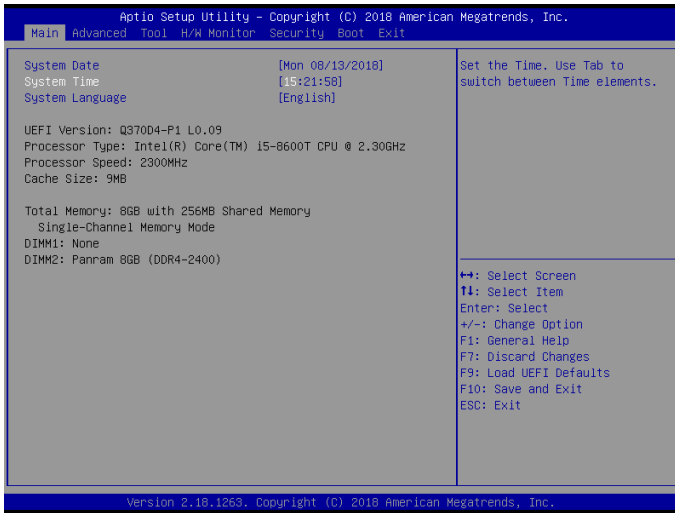

4.3 Advanced Screen

In this section, you may set the configurations for the following items: CPU Configuration, DRAM Configuration, Chipset Configuration, Storage Configuration, Super IO Configuration, ACPI Configuration, USB Configuration and Trusted Computing.

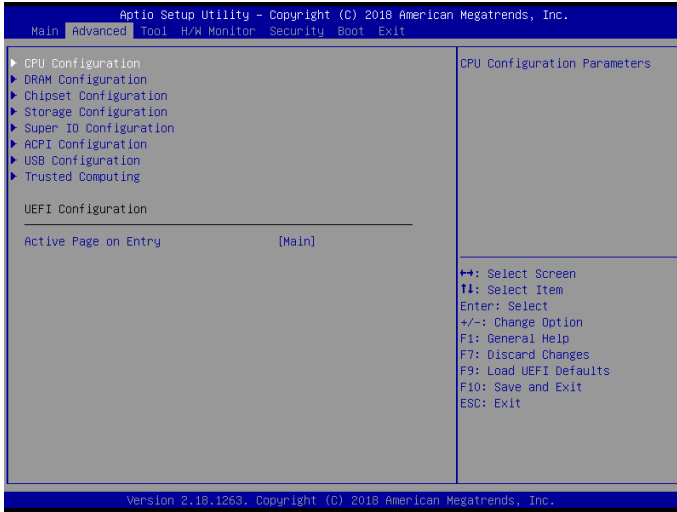

Setting wrong values in this section may cause the system to malfunction.

UEFI Configuration

Active Page on Entry

Select the default page when entering the UEFI setup utility.

4.3.1 CPU Configuration

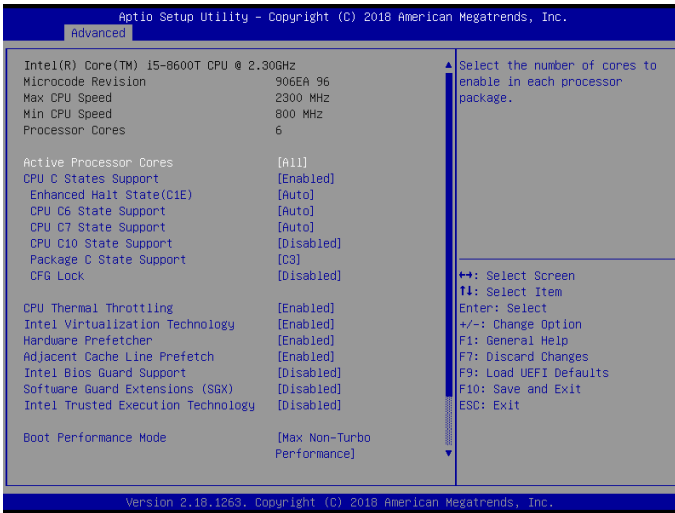

Intel Hyper Threading Technology

Intel Hyper Threading Technology allows multiple threads to run on each core, so that the overall performance on threaded software is improved.

Active Processor Cores

Select the number of cores to enable in each processor package.

CPU C States Support

Enable CPU C States Support for power saving. It is recommended to keep C3, C6 and C7 all enabled for better power saving.

Enhanced Halt State (C1E)

Enable Enhanced Halt State (C1E) for lower power consumption.

CPU C6 State Support

Enable C6 sleep state for lower power consumption.

CPU C7 State Support

Enable C7 sleep state for lower power consumption.

CPU C10 State Support

Enable C10 sleep state for lower power consumption.

Package C State Support

Enable CPU, PCIe, Memory, Graphics C State Support for power saving.

CFG Lock

This item allows you to disable or enable the CFG Lock.

CPU Thermal Throttling

Enable CPU internal thermal control mechanisms to keep the CPU from overheating.

Intel Virtualization Technology

Intel Virtualization Technology allows a platform to run multiple operating systems and applications in independent partitions, so that one computer system can function as multiple virtual systems.

Hardware Prefetcher

Automatically prefetch data and code for the processor. Enable for better performance.

Adjacent Cache Line Prefetch

Automatically prefetch the subsequent cache line while retrieving the currently requested cache line. Enable for better performance.

Software Guard Extensions (SGX)

Use this item to enable or disable Software Controlled Software Guard Extensions (SGX).

Intel Trusted Execution Technology

Use this item to enable or disable Intel Trusted Execution Technology (Intel TXT).

Boot Performance Mode

Default is Max Non-Turbo performance mode. It will keep cpu Flex-ratio till OS handoff. Max Battery mode will set CPU ratio as x8 till OS handoff. This option is suggested for BCLK overclocking.

FCLK Frequency

Configure the FCLK Frequency.

Intel SpeedStep Technology

Intel SpeedStep technology allows processors to switch between multiple frequencies and voltage points for better power saving and heat dissipation.

Intel Turbo Boost Technology

Intel Turbo Boost Technology enables the processor to run above its base operating frequency when the operating system requests the highest performance state.

Intel Speed Shift Technology

Enable/Disable Intel Speed Shift Technology support. Enabling will expose the CPPC v2 interface to allow for hardware controlled P-states.

4.3.2 DRAM Configuration

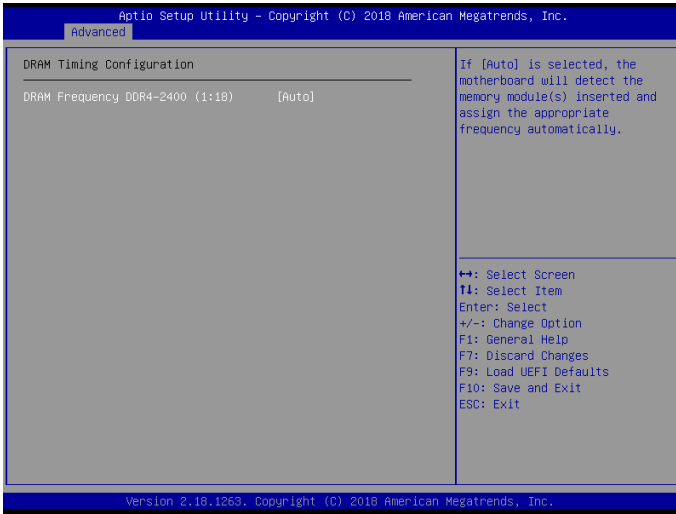

DRAM Timing Configuration

DRAM Reference Clock

Select Auto for optimized settings.

DRAM Frequency

If [Auto] is selected, the motherboard will detect the memory module(s) inserted and assign the appropriate frequency automatically.

4.3.3 Chipset Configuration

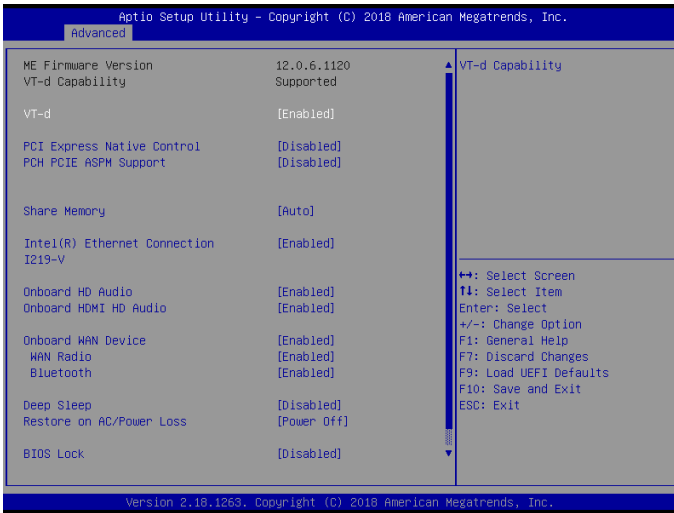

VT-d

Intel® Virtualization Technology for Directed I/O helps your virtual machine monitor better utilize hardware by improving application compatibility and reliability, and providing additional levels of manageability, security, isolation, and I/O performance.

PCI Express Native Control

Select Enable for enhanced PCI Express power saving in OS.

PCH PCIE ASPM Support

This option enables/disables the ASPM support for all PCH PCIE devices.

Share Memory

Configure the size of memory that is allocated to the integrated graphics processor when the system boots up.

Intel(R) Ethernet Connection I219-V

Enable or disable the onboard network interface controller (Intel® I219V).

Onboard HD Audio

Enable/disable onboard HD audio. Set to Auto to enable onboard HD audio and automatically disable it when a sound card is installed.

Onboard HDMI HD Audio

Enable audio for the onboard digital outputs.

WAN Radio

Enable/disable the WiFi module's connectivity.

Bluetooth

Enable/disable the bluetooth's connectivity

Deep Sleep

Configure deep sleep mode for power saving when the computer is shut down.

Restore on AC/Power Loss

Select the power state after a power failure. If [Power Off] is selected, the power will remain off when the power recovers. If [Power On] is selected, the system will start to boot up when the power recovers.

BIOS Lock

Enable/disable the PCH BIOS Lock Enable feature. Enable this item to ensure System Management Mode (SMM) protection of flash.

Performance Mode

Enable/disable the performance mode.

4.3.4 Storage Configuration

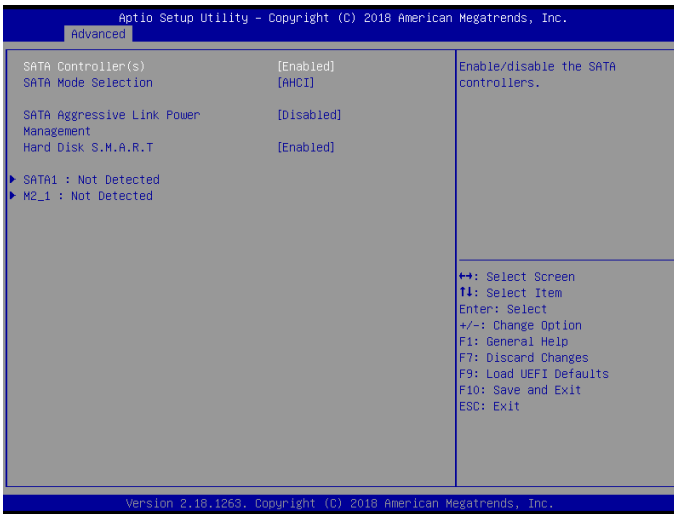

SATA Controller(s)

Enable/disable the SATA controllers.

SATA Aggressive Link Power Management

SATA Aggressive Link Power Management allows SATA devices to enter a low power state during periods of inactivity to save power. It is only supported by AHCI mode.

Hard Disk S.M.A.R.T.

S.M.A.R.T stands for Self-Monitoring, Analysis, and Reporting Technology. It is a monitoring system for computer hard disk drives to detect and report on various indicators of reliability.

4.3.5 Super IO Configuration

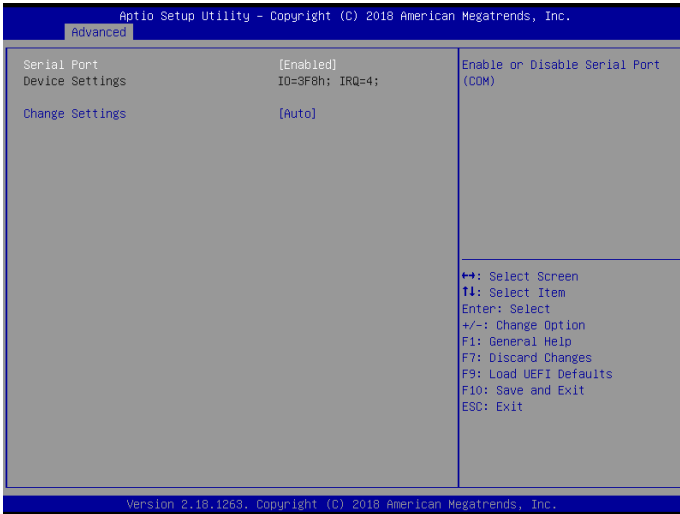

Serial Port

Enable or disable the Serial port.

Device Settings

Select the device mode according to your connected device.

Change Settings

Select the address of the Parallel port.

4.3.6 ACPI Configuration

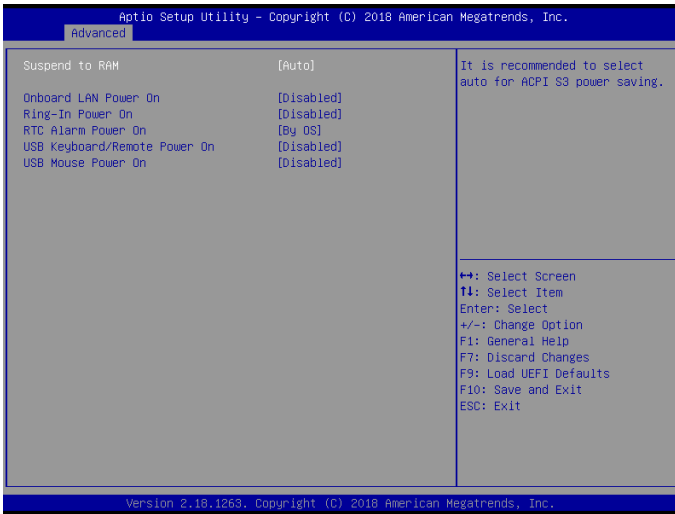

Suspend to RAM

Select disable for ACPI suspend type S1. It is recommended to select auto for ACPI S3 power saving.

Onboard LAN Power On

Allow the system to be waked up by onboard LAN.

Ring-In Power On

Allow the system to be waked up by onboard COM port modem Ring-In signals.

RTC Alarm Power On

Allow the system to be waked up by the real time clock alarm. Set it to By OS to let it be handled by your operating system.

USB Keyboard/Remote Power On

Allow the system to be waked up by an USB keyboard or remote controller.

USB Mouse Power On

Allow the system to be waked up by an USB mouse.

4.3.7 USB Configuration

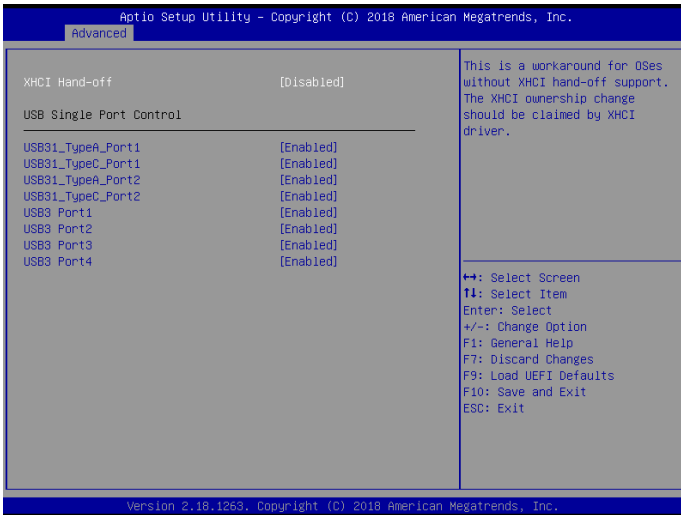

XHCI Hand-off

This is a workaround for OSes without XHCI hand-off support. The XHCI ownership change should be claimed by XHCI driver.

4.3.8 Trusted Computing

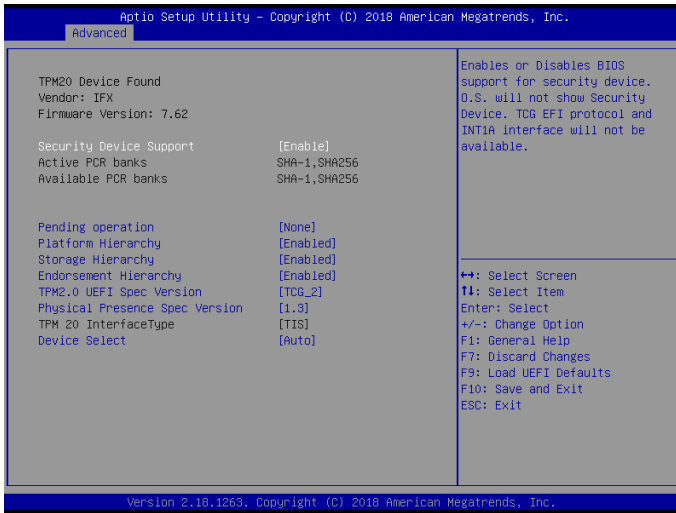

Security Device Support

Enable or disable BIOS support for security device.

4.4 Tools

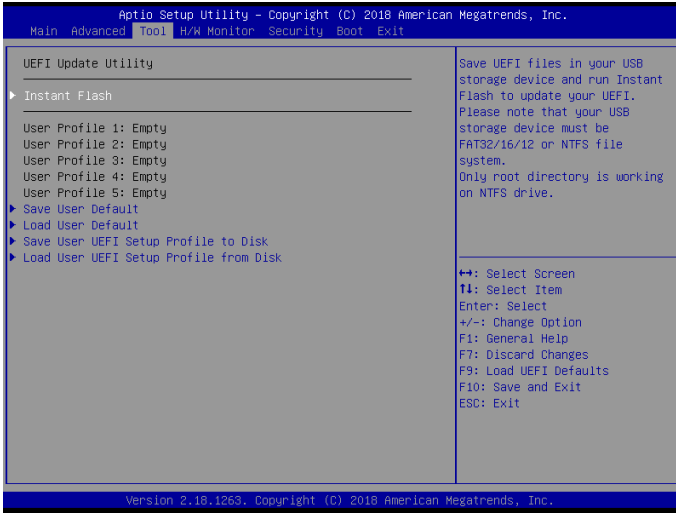

Instant Flash

Save UEFI files in your USB storage device and run Instant Flash to update your UEFI.

Save User Default

Type a profile name and press enter to save your settings as user default.

Load User Default

Load previously saved user defaults.

Save User UEFI Setup Profile to Disk

Save current UEFI settings as an user default profile to disk.

Load User UEFI Setup Profile to Disk

Load previously saved user defaults from the disk.

4.5 Hardware Health Event Monitoring Screen

This section allows you to monitor the status of the hardware on your system, including the parameters of the CPU temperature, motherboard temperature, fan speed and voltage.

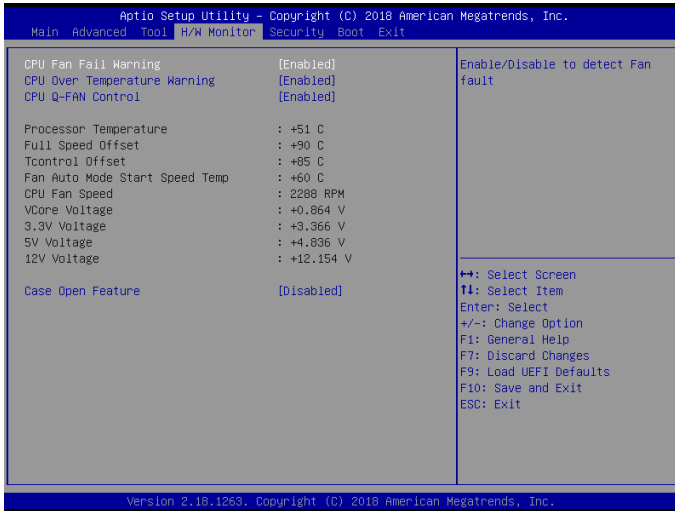

CPU Fan Fail Warning

Enable or disable the fan fail warning function.

CPU Over Temperature Warning

Enable or disable the CPU Over Temperature Warning function.

CPU Q-FAN Control

Enable or disable the CPU Q-Fan control feature.

Case Open Feature

Enable or disable Case Open Feature to detect whether the chassis cover has been removed.

4.6 Security Screen

In this section you may set or change the supervisor/user password for the system. You may also clear the user password.

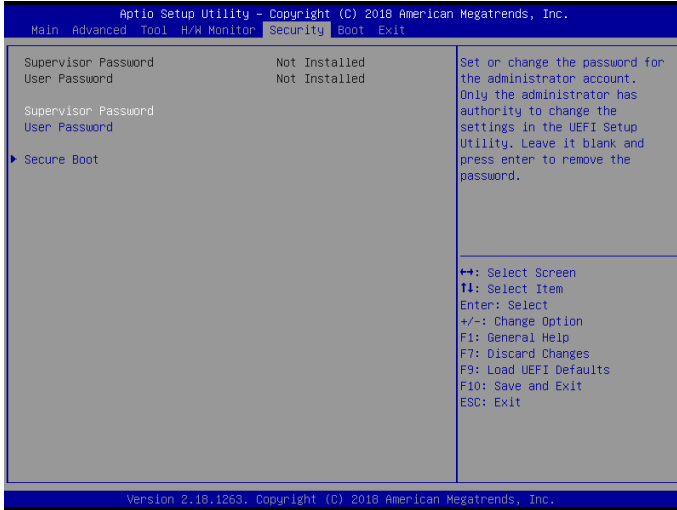

Supervisor Password

Set or change the password for the administrator account. Only the administrator has authority to change the settings in the UEFI Setup Utility. Leave it blank and press enter to remove the password.

User Password

Set or change the password for the user account. Users are unable to change the settings in the UEFI Setup Utility. Leave it blank and press enter to remove the password.

Secure Boot

Use this item to enable or disable support for Windows 8.1 Secure Boot.

4.7 Boot Screen

This section displays the available devices on your system for you to configure the boot settings and the boot priority.



Fast Boot

Fast Boot minimizes your computer's boot time. In fast mode you may not boot from an USB storage device. Ultra Fast mode is only supported by Windows 8.1 and the VBIOS must support UEFI GOP if you are using an external graphics card. Please notice that Ultra Fast mode will boot so fast that the only way to enter this UEFI Setup Utility is to Clear CMOS or run the Restart to UEFI utility in Windows.

Boot From Onboard LAN

Allow the system to be waked up by the onboard LAN.

Setup Prompt Timeout

Configure the number of seconds to wait for the setup hot key.

Bootup Num-Lock

Select whether Num Lock should be turned on or off when the system boots up.

Boot Beep

Select whether the Boot Beep should be turned on or off when the system boots up. Please note that a buzzer is needed.

Full Screen Logo

Enable to display the boot logo or disable to show normal POST messages.

AddOn ROM Display

Enable AddOn ROM Display to see the AddOn ROM messages or configure the AddOn ROM if you've enabled Full Screen Logo. Disable for faster boot speed.

Boot Failure Guard

If the computer fails to boot for a number of times the system automatically restores the default settings.

Boot Failure Guard Count

Configure the number of attempts to boot until the system automatically restores the default settings.

CSM (Compatibility Support Module)

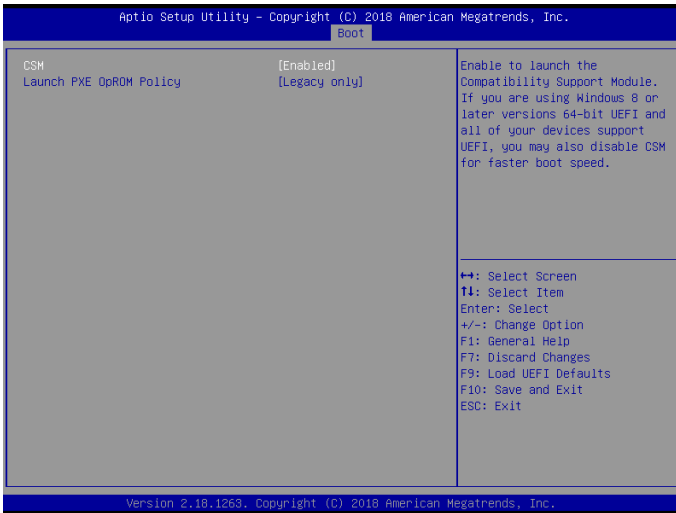

CSM

Enable to launch the Compatibility Support Module. Please do not disable unless you're running a WHCK test. If you are using Windows 8.1 64-bit and all of your devices support UEFI, you may also disable CSM for faster boot speed.

Launch PXE OpROM Policy

Select UEFI only to run those that support UEFI option ROM only. Select Legacy only to run those that support legacy option ROM only. Select Do not launch to not execute both legacy and UEFI option ROM.

4.8 Exit Screen

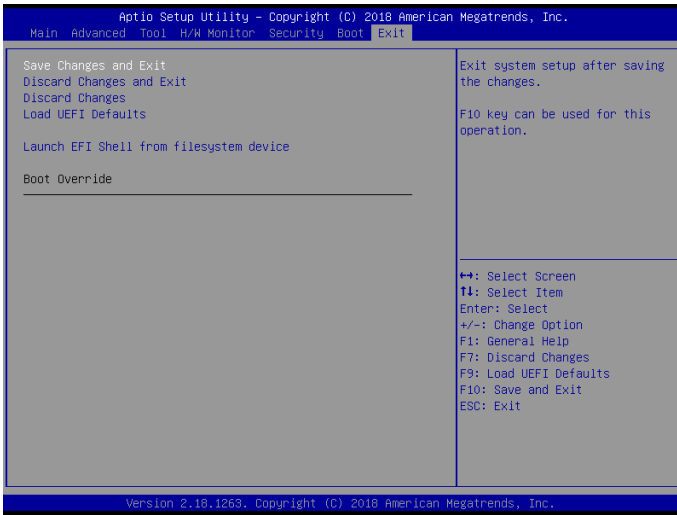

Save Changes and Exit

When you select this option the following message, “Save configuration changes and exit setup?” will pop out. Select [OK] to save changes and exit the UEFI SETUP UTILITY.

Discard Changes and Exit

When you select this option the following message, “Discard changes and exit setup?” will pop out. Select [OK] to exit the UEFI SETUP UTILITY without saving any changes.

Discard Changes

When you select this option the following message, “Discard changes?” will pop out. Select [OK] to discard all changes.

Load UEFI Defaults

Load UEFI default values for all options. The F9 key can be used for this operation.

Launch EFI Shell from filesystem device

Copy shellx64.efi to the root directory to launch EFI Shell.

DECLARATION OF CONFORMITY

Per FCC Part 2 Section 2.1077(a)



Product Name : Motherboard

Model Number : Q370D4-P1

Conforms to the following specifications:

FCC Part 15, Subpart B, Unintentional Radiators

Supplementary Information:

This device complies with part 15 of the FCC Rules. Operation is subject to the following two conditions: (1) This device may not cause harmful interference, and (2) this device must accept any interference received, including interference that may cause undesired operation.

EU Declaration of Conformity

For the following equipment:

Motherboard

(Product Name)

Q370D4-P1

(Model Designation / Trade Name)

EMC —Directive 2014/30/EU (from April 20th, 2016)

EN 55022:2010/AC:2011 Class B

EN 55024:2010/A1:2015

EN 55032:2012+AC:2013 Class B

EN 61000-3-3:2013

EN 61000-3-2:2014

LVD —Directive 2014/35/EU (from April 20th, 2016)

EN 60950-1 : 2011+ A2: 2013

EN 60950-1 : 2006/A12: 2011

RoHS — Directive 2011/65/EU

CE marking



(EU conformity marking)